



HAFİF YÜK TAŞIMA RULETLERİ



10-90kg Taşıma Kapasitesi

[İÇİNDEKİLER]



1200 Serisi 1-3



1300 Serisi 4-12



1500 Serisi 13-15



1600 Serisi 16-18



1700 Serisi 19-37



1800 Serisi 38-52



2100 Serisi 53-58



2700 Serisi 59-69

RULET KODLAMA SİSTEMİ

17	02
SERİ KODU	BAĞLANTI TİPİ
12	00 DELİKLİ
13	
15	01 CİVATA 3/8"
16	
17	01 CİVATA 5/8"
18	
21	02 TABLA
27	
	03 DAR TABLA
	
	04 PİM
	
	05 PİM
	
	07 SABİT MAŞA
	
	11 CİVATA
	
	12 TABLA
	
	14 PİM
	
	25 AYARLI BAŞLIK (OYNAK)
	

M	T	B
GÖVDE CİNSİ	SIRT MALZEMESİ	YATAK TİPİ
A POLİAMİD	A POLİAMİD	A
B İSİYA DAYANIKLI BAKALİT	B İSİYA DAYANIKLI BAKALİT	B BURÇ YATAKLAMASI GÖVDENİN KENDİ
C TAKVİYELİ PP	C PLASTİK (P.V.C.)	C İSİYA DAYANIKLI BURÇ
D PİK (DÖKÜM)	D PİK (DÖKÜM)	D DEMİR BURÇ
E	E GRİ LASTİK	E
F POLİAMİD 6 KÜTÜK	F POLİAMİD 6 KÜTÜK	F
G	G	G
H POLİKARBONAT	H HAVALI LASTİK	H
I	I	I
K KAMALON	K KAMALON	K
L	L SİYAH LASTİK	L
M POLİPROPİLEN	M POLİPROPİLEN	M DİZME MİSKET BİLYALI YATAKLAMA
N TAKVİYELİ POLİAMİD 6	N TAKVİYELİ POLİAMİD 6	N
O	O DÖKME POLİÜRETAN	O
P POLİAMİD 6	P POLİAMİD 6	P POLİAMİD BURÇLU YATAKLAMA
R AĞIR TİP	R MAVİ LASTİK	R BİLYA RULMANLI YATAKLAMA
S SAC	S YARI HAVALI (DUBLEKS) LASTİK	S MASURALI YATAKLAMA
T	T TERMOELASTİK LASTİK	T
U	U ENJEKSİYON BASKI POLİÜRETAN	U
V	V VULKANİZE LASTİK	V
Y	Y AĞIR TİP VULKANİZE LASTİK	Y
Z ALAŞIMLI ALÜMİNYUM	Z	Z

075
TEKER ÇAPı (Ømm)
28
32
38
40
50
60
70
75
90
95
100

F04
FREN SİSTEMİ
F01

F02

F04

F18



T
İLAVE BİLGİ HANESİ
T





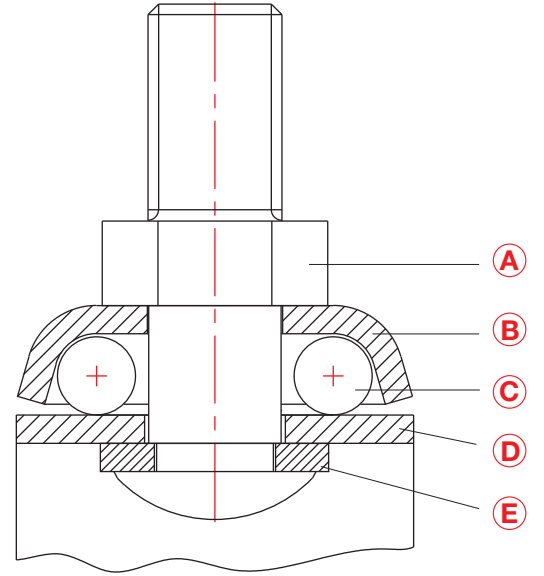

SAC JANT KAPAKLI
K

KARE SOKET
Y



YUVARLAK SOKET

- A:** BAĞLANTI CİVATASI
B: ÜST BİLYA KAPAĞI
C: KÜRESEL METAL TANE BİLYALAR
D: OYNAK RULET MAŞASI
E: MONTAJ PULU







MMB		MOBLEN TEKER BURÇLU						
KOD NO	 mm	 mm	 mm	 mm	 mm	 mm	 kg	
1201 MMB 050	50	20	71.5	15	3/8"	15.5	20	



MTB		MOBLEN KASNAK ÜZERİ TERMOELASTİK KAPLI BURÇLU						
KOD NO	 mm	 mm	 mm	 mm	 mm	 mm	 kg	
1201 MTB 050	50	20	71.5	15	3/8"	15.5	20	



HCB		POLİKARBONAT KASNAK ÜZERİ P.V.C. KAPLAMA BURÇLU						
KOD NO	 mm	 mm	 mm	 mm	 mm	 mm	 kg	
1201 HCB 050	50	20	71.5	15	3/8"	15.5	20	

- A:** OYNAK BAĞLANTI TABLASI
- B:** TABLA BAĞLANTI PERÇİNİ
- C:** ÜST BİLYA KAPAĞI
- D:** KÜRESEL METAL TANE BİLYALAR
- E:** OYNAK RULET MAŞASI
- F:** MONTAJ PULU

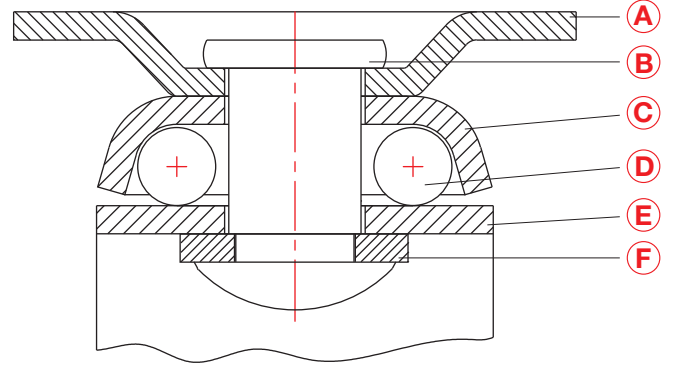

MMB		MOBLEN TEKER BURÇLU						
KOD NO								
	mm	mm	mm	mm	mm	mm	mm	kg
1202 MMB 050	50	20	73	15	42.5x40	30x28	6	20



MTB		MOBLEN KASNAK ÜZERİ TERMOELASTİK KAPLI BURÇLU						
KOD NO								
	mm	mm	mm	mm	mm	mm	mm	kg
1202 MTB 050	50	20	73	15	42.5x40	30x28	6	20



HCB		POLİKARBONAT KASNAK ÜZERİ P.V.C. KAPLAMA BURÇLU						
KOD NO								
	mm	mm	mm	mm	mm	mm	mm	kg
1202 HCB 050	50	20	73	15	42.5x40	30x28	6	20



YUVARLAK BAŞLIK



KARE BAŞLIK

- A: BAĞLANTI PİMİ
- B: OYNAK RULET MAŞASI
- C: MONTAJ PULU

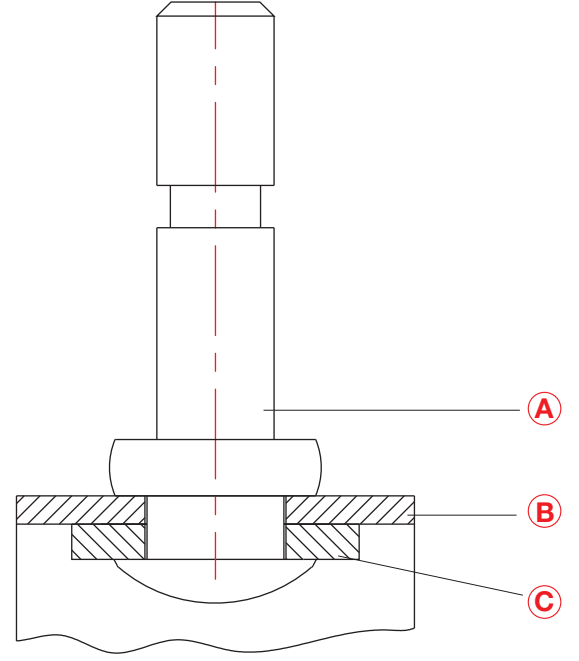

MMB		MOBLEN TEKER BURÇLU					
KOD NO	mm	mm	mm	mm	mm	mm	kg
1204 MMB 050	50	20	62	15	8.3	31	20
1204 MMB 075	75	25	89	21	8.3	31	30



MTB		MOBLEN KASNAK ÜZERİ TERMOELASTİK KAPLI BURÇLU					
KOD NO	mm	mm	mm	mm	mm	mm	kg
1204 MTB 050	50	20	62	15	8.3	31	20
1204 MTB 075	75	25	89	21	8.3	31	30



HCB		POLİKARBONAT KASNAK ÜZERİ P.V.C. KAPLAMA BURÇLU					
KOD NO	mm	mm	mm	mm	mm	mm	kg
1204 HCB 050	50	20	62	15	8.3	31	20
1204 HCB 075	75	25	89	21	8.3	31	30



- A:** OYNAK RULET MAŞASI
B: KÜRESEL METAL TANE BİLYALAR
C: ÜST BİLYA KAPAĞI

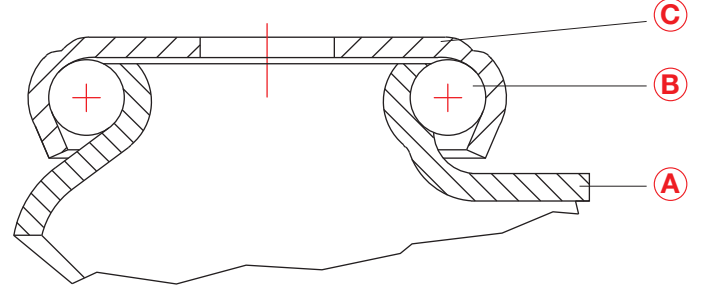

MMB		MOBLEN TEKER BURÇLU					
KOD NO	mm	mm	mm	mm	mm	kg	
1300 MMB 050	50	20	65	21	10	30	
1300 MMB 075	75	25	97	30	10	40	



MMB		MOBLEN TEKER BURÇLU					
KOD NO	mm	mm	mm	mm	mm	mm	kg
1300 MMB 050 F04	50	20	65	21	71	10	30
1300 MMB 075 F04	75	25	97	30	78	10	40









MTB		MOBLEN KASNAK ÜZERİ TERMOELASTİK KAPLI BURÇLU					
KOD NO	mm	mm	mm	mm	mm	kg	
1300 MTB 050	50	20	65	21	10	30	
1300 MTB 075	75	25	97	30	10	40	









MTB		MOBLEN KASNAK ÜZERİ TERMOELASTİK KAPLI BURÇLU					
KOD NO	mm	mm	mm	mm	mm	mm	kg
1300 MTB 050 F04	50	20	65	21	71	10	30
1300 MTB 075 F04	75	25	97	30	78	10	40









MTR		MOBLEN KASNAK ÜZERİ TERMOELASTİK KAPLAMA RULMANLI					
KOD NO	 mm	 mm	 mm	 mm	 mm	 kg	
1300 MTR 050	50	20	65	21	10	30	
1300 MTR 075	75	25	97	30	10	40	









MTR		MOBLEN KASNAK ÜZERİ TERMOELASTİK KAPLAMA RULMANLI					
KOD NO	 mm	 mm	 mm	 mm	 mm	 mm	 kg
1300 MTR 050 F04	50	20	65	21	71	10	30
1300 MTR 075 F04	75	25	97	30	78	10	40



HCB		POLİKARBONAT KASNAK ÜZERİ P.V.C. KAPLAMA BURÇLU					
KOD NO	 mm	 mm	 mm	 mm	 mm	 kg	
1300 HCB 050	50	20	65	21	10	30	
1300 HCB 075	75	25	97	30	10	40	



HCB		POLİKARBONAT KASNAK ÜZERİ P.V.C. KAPLAMA BURÇLU					
KOD NO	 mm	 mm	 mm	 mm	 mm	 mm	 kg
1300 HCB 050 F04	50	20	65	21	71	10	30
1300 HCB 075 F04	75	25	97	30	78	10	40

- A:** OYNAK RULET MAŞASI
B: KÜRESEL METAL TANE BİLYALAR
C: ÜST BİLYA KAPAĞI
D: BAĞLANTI CİVATASI

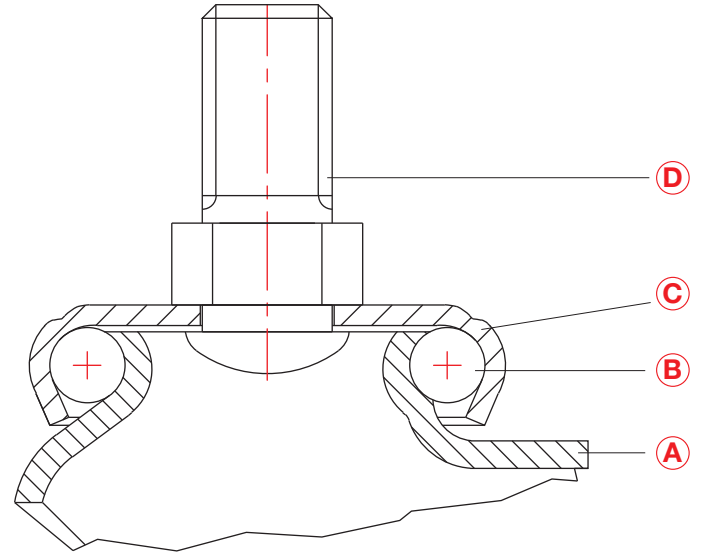







MMB		MOBLEN TEKER BURÇLU						
KOD NO	mm	mm	mm	mm	mm	mm	kg	
1301 MMB 050	50	20	71	21	3/8",M10	15	30	
1301 MMB 075	75	25	103	30	3/8",M10	15	40	

MMB		MOBLEN TEKER BURÇLU						
KOD NO	mm	mm	mm	mm	mm	mm	kg	
1301 MMB 050 F04	50	20	71	21	71	3/8",M10	30	
1301 MMB 075 F04	75	25	103	30	78	3/8",M10	40	









MTB		MOBLEN KASNAK ÜZERİ TERMOELASTİK KAPLI BURÇLU						
KOD NO	mm	mm	mm	mm	mm	mm	kg	
1301 MTB 050	50	20	71	21	3/8",M10	15	30	
1301 MTB 075	75	25	103	30	3/8",M10	15	40	

MTB		MOBLEN KASNAK ÜZERİ TERMOELASTİK KAPLI BURÇLU						
KOD NO	mm	mm	mm	mm	mm	mm	kg	
1301 MTB 050 F04	50	20	71	21	71	3/8",M10	30	
1301 MTB 075 F04	75	25	103	30	78	3/8",M10	40	









MTR		MOBLEN KASNAK ÜZERİ TERMOELASTİK KAPLAMA RULMANLI						
KOD NO	 mm	 mm	 mm	 mm	 mm	 mm	 kg	
1301 MTR 050	50	20	71	21	3/8",M10	15	30	
1301 MTR 075	75	25	103	30	3/8",M10	15	40	











MTR		MOBLEN KASNAK ÜZERİ TERMOELASTİK KAPLAMA RULMANLI						
KOD NO	 mm	 mm	 mm	 mm	 mm	 mm	 mm	 kg
1301 MTR 050 F04	50	20	71	21	71	3/8",M10	15	30
1301 MTR 075 F04	75	25	103	30	78	3/8",M10	15	40



HCB		POLİKARBONAT KASNAK ÜZERİ P.V.C. KAPLAMA BURÇLU						
KOD NO	 mm	 mm	 mm	 mm	 mm	 mm	 kg	
1301 HCB 050	50	20	71	21	3/8",M10	15	30	
1301 HCB 075	75	25	103	30	3/8",M10	15	40	



HCB		POLİKARBONAT KASNAK ÜZERİ P.V.C. KAPLAMA BURÇLU						
KOD NO	 mm	 mm	 mm	 mm	 mm	 mm	 mm	 kg
1301 HCB 050 F04	50	20	71	21	71	3/8",M10	15	30
1301 HCB 075 F04	75	25	103	30	78	3/8",M10	15	40

050'LİK TABLA

075'LİK TABLA

- A:** OYNAK RULET MAŞASI
B: KÜRESEL METAL TANE BİLYALAR
C: ÜST BİLYA KAPAĞI
D: OYNAK BAĞLANTI TABLASI
E: TABLA BAĞLANTI PERÇİNİ

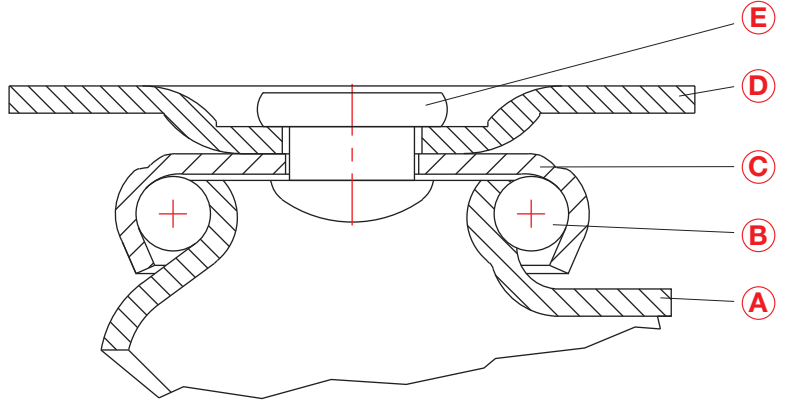

MMB		MOBLEN TEKER BURÇLU						
KOD NO								
	mm	mm	mm	mm	mm	mm	mm	kg
1302 MMB 050	50	20	70	21	51x51	37x37	6.5	30
1302 MMB 075	75	25	103	30	64x64	49x49	6.5x12	40



MMB		MOBLEN TEKER BURÇLU							
KOD NO									
	mm	mm	mm	mm	mm	mm	mm	kg	
1302 MMB 050 F04	50	20	70	21	71	51x51	37x37	6.5	30
1302 MMB 075 F04	75	25	103	30	78	64x64	49x49	6.5x12	40







MTB		MOBLEN KASNAK ÜZERİ TERMOELASTİK KAPLI BURÇLU						
KOD NO								
	mm	mm	mm	mm	mm	mm	mm	kg
1302 MTB 050	50	20	70	21	51x51	37x37	6.5	30
1302 MTB 075	75	25	103	30	64x64	49x49	6.5x12	40











MTB		MOBLEN KASNAK ÜZERİ TERMOELASTİK KAPLI BURÇLU							
KOD NO									
	mm	mm	mm	mm	mm	mm	mm	kg	
1302 MTB 050 F04	50	20	70	21	71	51x51	37x37	6.5	30
1302 MTB 075 F04	75	25	103	30	78	64x64	49x49	6.5x12	40



MTR		MOBLEN KASNAK ÜZERİ TERMOELASTİK KAPLAMA RULMANLI						
KOD NO								
	mm	mm	mm	mm	mm	mm	mm	kg
1302 MTR 050	50	20	70	21	51x51	37x37	6.5	30
1302 MTR 075	75	25	103	30	64x64	49x49	6.5x12	40











MTR		MOBLEN KASNAK ÜZERİ TERMOELASTİK KAPLAMA RULMANLI							
KOD NO									
	mm	mm	mm	mm	mm	mm	mm	mm	kg
1302 MTR 050 F04	50	20	70	21	71	51x51	37x37	6.5	30
1302 MTR 075 F04	75	25	103	30	78	64x64	49x49	6.5x12	40



HCB		POLİKARBONAT KASNAK ÜZERİ P.V.C. KAPLAMA BURÇLU						
KOD NO								
	mm	mm	mm	mm	mm	mm	mm	kg
1302 HCB 050	50	20	70	21	51x51	37x37	6.5	30
1302 HCB 075	75	25	103	30	64x64	49x49	6.5x12	40



HCB		POLİKARBONAT KASNAK ÜZERİ P.V.C. KAPLAMA BURÇLU							
KOD NO									
	mm	mm	mm	mm	mm	mm	mm	mm	kg
1302 HCB 050 F04	50	20	70	21	71	51x51	37x37	6.5	30
1302 HCB 075 F04	75	25	103	30	78	64x64	49x49	6.5x12	40

- A:** OYNAK RULET MAŞASI
B: KÜRESEL METAL TANE BİLYALAR
C: ÜST BİLYA KAPAĞI
D: BAĞLANTI PİMİ

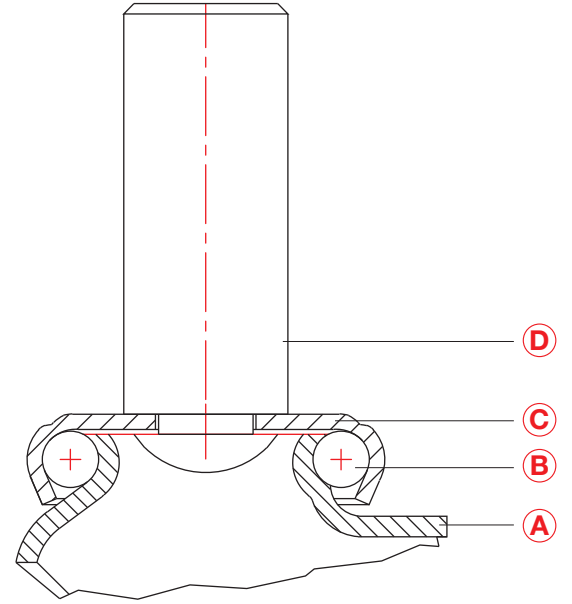
MMB
MOBLEN TEKER BURÇLU

KOD NO	mm	mm	mm	mm	mm	mm	mm	kg
1305 MMB 050	50	20	65	21	16	40		30
1305 MMB 075	75	25	97	30	19	40		40

MMB
MOBLEN TEKER BURÇLU

KOD NO	mm	mm	mm	mm	mm	mm	mm	kg
1305 MMB 050 F04	50	20	65	21	71	16	40	30
1305 MMB 075 F04	75	25	97	30	78	19	40	40

MTB
MOBLEN KASNAK ÜZERİ TERMOELASTİK KAPLI BURÇLU







KOD NO	mm	mm	mm	mm	mm	mm	mm	kg
1305 MTB 050	50	20	65	21	16	40		30
1305 MTB 075	75	25	97	30	19	40		40

MTB
MOBLEN KASNAK ÜZERİ TERMOELASTİK KAPLI BURÇLU







KOD NO	mm	mm	mm	mm	mm	mm	mm	kg
1305 MTB 050 F04	50	20	65	21	71	16	40	30
1305 MTB 075 F04	75	25	97	30	78	19	40	40











MTR
MOBLEN KASNAK ÜZERİ TERMOELASTİK KAPLAMA RULMANLI

KOD NO	 mm	 mm	 mm	 mm	 mm	 mm	 kg
1305 MTR 050	50	20	65	21	16	40	30
1305 MTR 075	75	25	97	30	19	40	40









MTR
MOBLEN KASNAK ÜZERİ TERMOELASTİK KAPLAMA RULMANLI

KOD NO	 mm	 mm	 mm	 mm	 mm	 mm	 kg
1305 MTR 050 F04	50	20	65	21	71	16	30
1305 MTR 075 F04	75	25	97	30	78	19	40







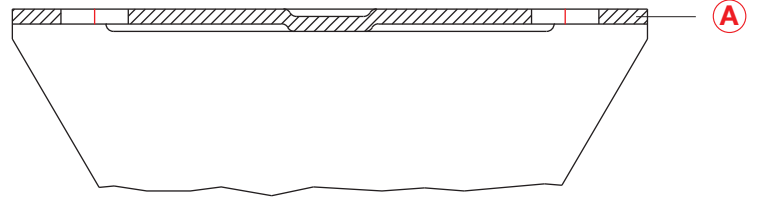
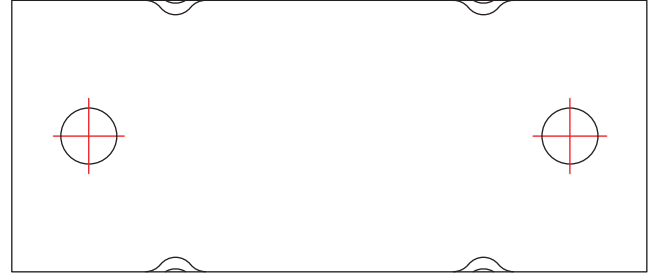

HCB
POLİKARBONAT KASNAK ÜZERİ P.V.C. KAPLAMA BURÇLU

KOD NO	 mm	 mm	 mm	 mm	 mm	 mm	 kg
1305 HCB 050	50	20	65	21	16	40	30
1305 HCB 075	75	25	97	30	19	40	40









HCB
POLİKARBONAT KASNAK ÜZERİ P.V.C. KAPLAMA BURÇLU

KOD NO	 mm	 mm	 mm	 mm	 mm	 mm	 kg
1305 HCB 050 F04	50	20	65	21	71	16	30
1305 HCB 075 F04	75	25	97	30	78	19	40







A: SABİT MAŞA

MMB
MOBLEN TEKER BURÇLU

KOD NO	 mm	 mm	 mm	 mm	 mm	 mm	 kg
1307 MMB 050	50	20	68	66x28	50	6	30
1307 MMB 075	75	25	93	85x37	63	9	40









MTB
MOBLEN KASNAK ÜZERİ TERMOELASTİK KAPLAMA BURÇLU

KOD NO	 mm	 mm	 mm	 mm	 mm	 mm	 kg
1307 MTB 050	50	20	68	66x28	50	6	30
1307 MTB 075	75	25	93	85x37	63	9	40



MTR
MOBLEN KASNAK ÜZERİ TERMOELASTİK KAPLAMA RULMANLI



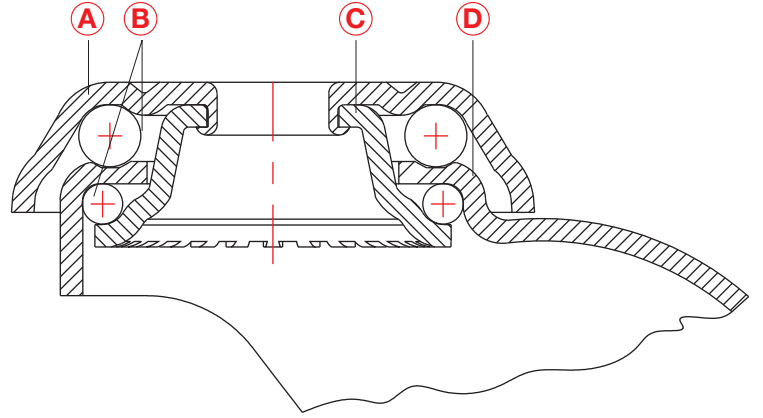

KOD NO	 mm	 mm	 mm	 mm	 mm	 mm	 kg
1307 MTR 050	50	20	68	66x28	50	6	30
1307 MTR 075	75	25	93	85x37	63	9	40

HCB
POLİKARBONAT KASNAK ÜZERİ P.V.C. KAPLAMA BURÇLU





KOD NO	 mm	 mm	 mm	 mm	 mm	 mm	 kg
1307 HCB 050	50	20	68	66x28	50	6	30
1307 HCB 075	75	25	93	85x37	63	9	40

- A:** ÜST BİLYA KAPAĞI
B: KÜRESEL METAL TANE BİLYALAR
C: ALT BİLYA ÇANAĞI
D: OYNAK RULET MAŞASI



MMB		MOBLEN TEKER BURÇLU			
KOD NO	 mm	 mm	 mm	 mm	 kg
1500 MMB 040	40	52	20	8	20
1500 MMB 050	50	68	24	10	30



MTB		MOBLEN KASNAK ÜZERİ TERMOELASTİK KAPLI BURÇLU			
KOD NO	 mm	 mm	 mm	 mm	 kg
1500 MTB 040	40	52	20	8	20
1500 MTB 050	50	68	24	10	30

- A:** ÜST BİLYA KAPAĞI
B: KÜRESEL METAL TANE BİLYALAR
C: BAĞLANTI CİVATASI
D: ALT BİLYA ÇANAĞI
E: OYNAK RULET MAŞASI

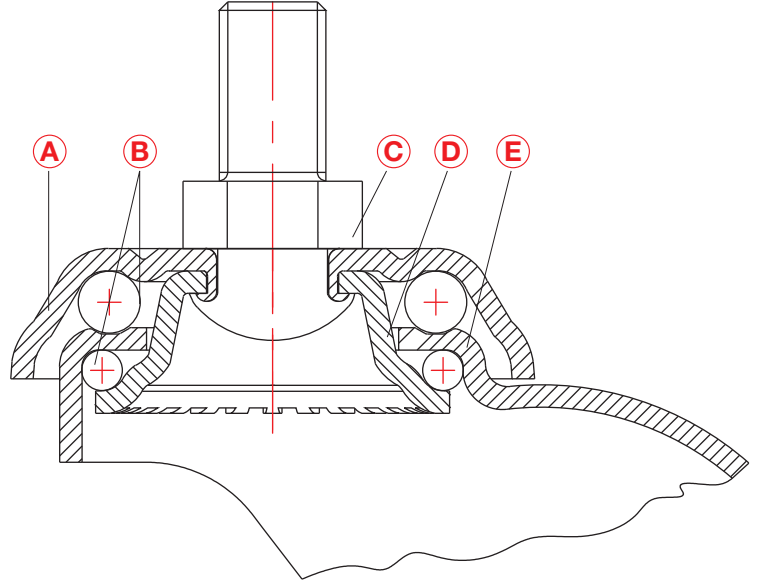







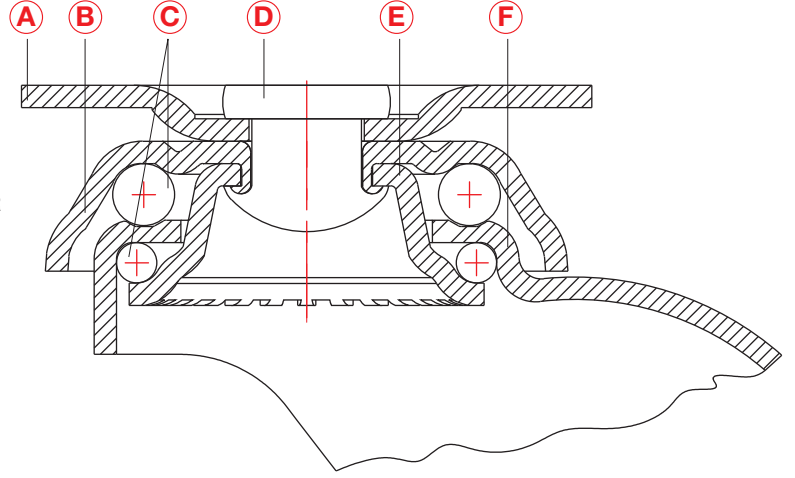

MMB		MOBLEN TEKER BURÇLU				
KOD NO	mm	mm	mm	mm	mm	kg
1501 MMB 040	40	58	20	3/8",M10	15	20
1501 MMB 050	50	74	24	3/8",M10	15	30









MTB		MOBLEN KASNAK ÜZERİ TERMOELASTİK KAPLI BURÇLU				
KOD NO	mm	mm	mm	mm	mm	kg
1501 MTB 040	40	58	20	3/8",M10	15	20
1501 MTB 050	50	74	24	3/8",M10	15	30

- A:** OYNAK BAĞLANTI TABLASI
B: ÜST BİLYA KAPAĞI
C: KÜRESEL METAL TANE BİLYALAR
D: TABLA BAĞLANTI PERÇİNİ
E: ALT BİLYA ÇANAĞI
F: OYNAK RULET MAŞASI









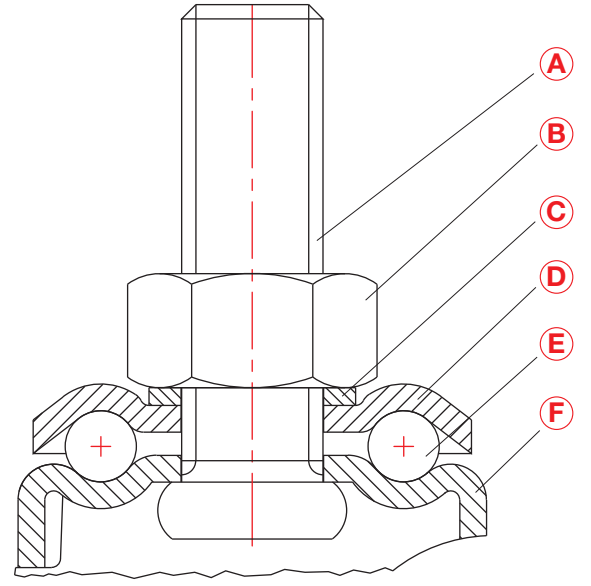

MMB		MOBLEN TEKER BURÇLU						
KOD NO	 mm	 mm	 mm	 mm	 mm	 mm	 kg	
1502 MMB 040	40	55	20	42.5x39.5	30x27	6	20	
1502 MMB 050	50	73	24	51x51	37x37	6	30	



MTB		MOBLEN KASNAK ÜZERİ TERMOELASTİK KAPLI BURÇLU						
KOD NO	 mm	 mm	 mm	 mm	 mm	 mm	 kg	
1502 MTB 040	40	55	20	42.5x39.5	30x27	6	20	
1502 MTB 050	50	73	24	51x51	37x37	6	30	

- A:** BAĞLANTI CİVATASI
B: MONTAJ SOMUNU
C: MONTAJ PULU
D: ÜST BİLYA KAPAĞI
E: KÜRESEL METAL TANE BİLYALAR
F: OYNAK RULET MAŞASI



MMB		MOBLEN TEKER BURÇLU					
KOD NO	 mm	 mm	 mm	 mm	 mm	 mm	 kg
1601 MMB 028	28	14	47	7.6	5/16",M8	15	10
1601 MMB 032	32	14	50	9.6	5/16",M8	15	15
1601 MMB 038	38	14	57.5	8.5	5/16",M8	15	20



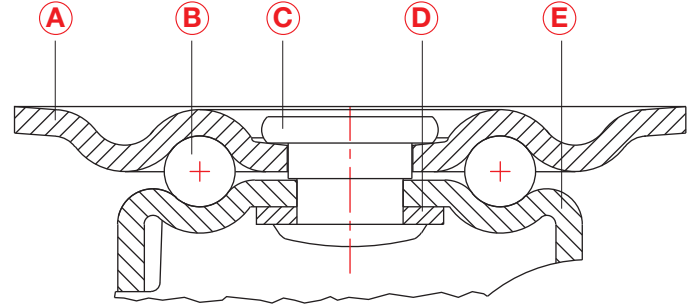



- A:** BAĞLANTI TABLASI
- B:** KÜRESEL METAL TANE BİLYALAR
- C:** TABLA BAĞLANTI PERÇİNİ
- D:** MONTAJ RONDELASI
- E:** OYNAK RULET MAŞASI

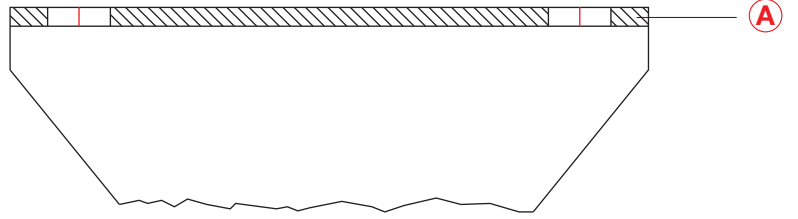
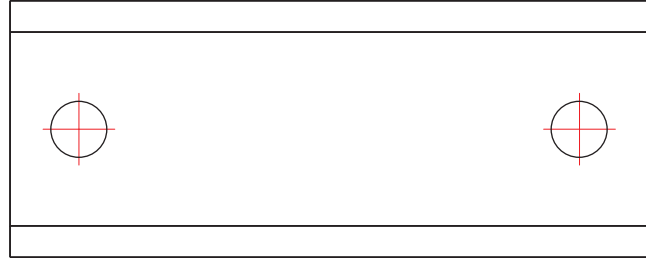

MMB		MOBLEN TEKER BURÇLU						
KOD NO	mm	mm	mm	mm	mm	mm	mm	kg
1602 MMB 028	28	14	40	7.6	38x32	30x23	4.5	10
1602 MMB 032	32	14	43	9.6	38x32	30x23	4.5	15
1602 MMB 038	38	14	50.5	8.5	38x32	30x23	4.5	20







A: SABİT MAŞA

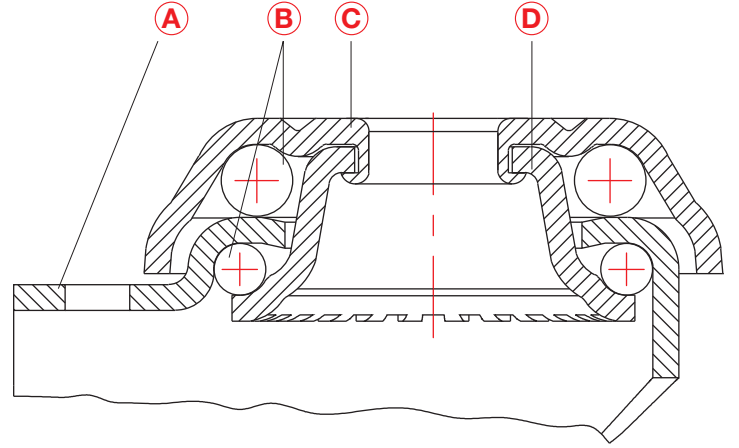













MMB		MOBLEN TEKER BURÇLU					
KOD NO	 mm	 mm	 mm	 mm	 mm	 mm	 kg
1607 MMB 028	28	14	40	48x20.5	35	5	10
1607 MMB 032	32	14	43	51x20.5	40	5	15
1607 MMB 038	38	14	50.5	56.5x20.5	44	5	20







- A:** OYNAK RULET MAŞASI
B: KÜRESEL METAL TANE BİLYALAR
C: ÜST BİLYA KAPAĞI
D: ALT BİLYA ÇANAĞI









MMB		MOBLEN TEKER BURÇLU					
KOD NO	 mm	 mm	 mm	 mm	 mm	 kg	
1700 MMB 050	50	20	71	25	10	35	
1700 MMB 075	75	25	97	31	10	45	
1700 MMB 100	100	25	122	35	10	55	

MMB		MOBLEN TEKER BURÇLU					
KOD NO	 mm	 mm	 mm	 mm	 mm	 mm	 kg
1700 MMB 050 F18	50	20	71	27	74	10	35
1700 MMB 075 F18	75	25	97	33	88	10	45
1700 MMB 100 F18	100	25	122	28	95	10	55







MTB		MOBLEN KASNAK ÜZERİ TERMOELASTİK KAPLAMA BURÇLU					
KOD NO	 mm	 mm	 mm	 mm	 mm	 kg	
1700 MTB 050	50	20	71	25	10	35	
1700 MTB 075	75	25	97	31	10	45	
1700 MTB 100	100	25	122	35	10	55	

MTB		MOBLEN KASNAK ÜZERİ TERMOELASTİK KAPLAMA BURÇLU					
KOD NO	 mm	 mm	 mm	 mm	 mm	 mm	 kg
1700 MTB 050 F18	50	20	71	27	74	10	35
1700 MTB 075 F18	75	25	97	33	88	10	45
1700 MTB 100 F18	100	25	122	28	95	10	55









MTR		MOBLEN KASNAK ÜZERİ TERMOELASTİK KAPLAMA RULMANLI					
KOD NO	 mm	 mm	 mm	 mm	 mm	 kg	
1700 MTR 050	50	20	71	25	10	35	
1700 MTR 075	75	25	97	31	10	45	









MTR		MOBLEN KASNAK ÜZERİ TERMOELASTİK KAPLAMA RULMANLI					
KOD NO	 mm	 mm	 mm	 mm	 mm	 mm	 kg
1700 MTR 050 F18	50	20	71	27	74	10	35
1700 MTR 075 F18	75	25	97	33	88	10	45









PCR		POLİAMİD KASNAK ÜZERİ P.V.C. KAPLAMA RULMANLI					
KOD NO	 mm	 mm	 mm	 mm	 mm	 kg	
1700 PCR 100	100	25	122	35	10	55	









PCR		POLİAMİD KASNAK ÜZERİ P.V.C. KAPLAMA RULMANLI					
KOD NO	 mm	 mm	 mm	 mm	 mm	 mm	 kg
1700 PCR 100 F18	100	25	122	28	95	10	55









PPB		POLİAMİD TEKER BURÇLU					
KOD NO	 mm	 mm	 mm	 mm	 mm	 kg	
1700 PPB 050	50	20	75.5	25	10	35	
1700 PPB 075	75	25	105	31	10	45	
1700 PPB 100	100	25	128	35	10	55	









PPB		POLİAMİD TEKER BURÇLU					
KOD NO	 mm	 mm	 mm	 mm	 mm	 mm	 kg
1700 PPB 050 F18	50	20	75.5	27	74	10	35
1700 PPB 075 F18	75	25	105	33	86	10	45
1700 PPB 100 F18	100	25	128	28	98	10	55



HCB		POLİKARBONAT KASNAK ÜZERİ P.V.C. KAPLAMA BURÇLU					
KOD NO	 mm	 mm	 mm	 mm	 mm	 kg	
1700 HCB 050	50	20	71	25	10	35	
1700 HCB 075	75	25	97	31	10	45	



HCB		POLİKARBONAT KASNAK ÜZERİ P.V.C. KAPLAMA BURÇLU					
KOD NO	 mm	 mm	 mm	 mm	 mm	 mm	 kg
1700 HCB 050 F18	50	20	71	27	74	10	35
1700 HCB 075 F18	75	25	97	33	88	10	45

- A:** BAĞLANTI CİVATASI
B: ÜST BİLYA KAPAĞI
C: KÜRESEL METAL TANE BİLYALAR
D: OYNAK RULET MAŞASI
E: ALT BİLYA ÇANAĞI

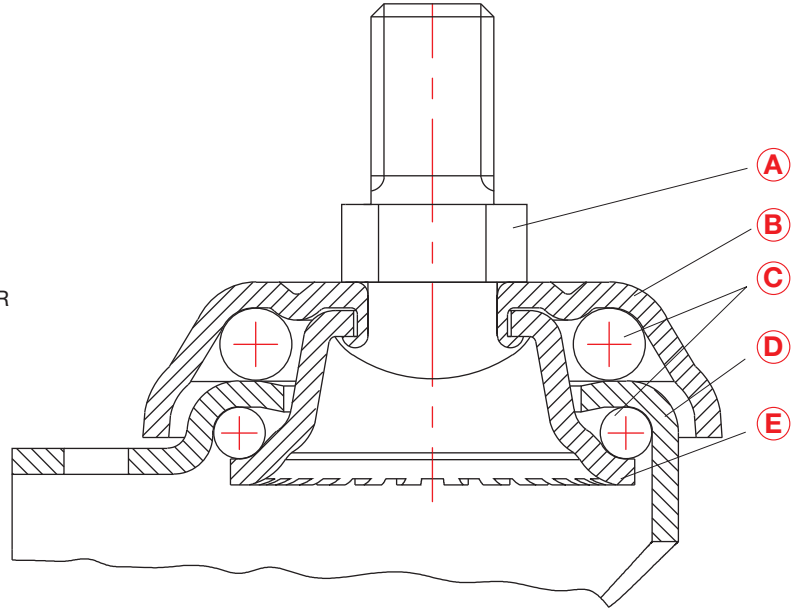
MMB MOBLEN TEKER BURÇLU

KOD NO	mm	mm	mm	mm	mm	mm	kg
1701 MMB 050	50	20	75.5	25	3/8",M10	15	35
1701 MMB 075	75	25	105	31	3/8",M10	15	45
1701 MMB 100	100	25	128	35	3/8",M10	15	55

MMB MOBLEN TEKER BURÇLU

KOD NO	mm	mm	mm	mm	mm	mm	kg	
1701 MMB 050 F18	50	20	75.5	27	74	3/8",M10	15	35
1701 MMB 075 F18	75	25	105	33	86	3/8",M10	15	45
1701 MMB 100 F18	100	25	128	28	98	3/8",M10	15	55

MTB MOBLEN KASNAK ÜZERİ TERMOELASTİK KAPLAMA BURÇLU







KOD NO	mm	mm	mm	mm	mm	mm	kg
1701 MTB 050	50	20	75.5	25	3/8",M10	15	35
1701 MTB 075	75	25	105	31	3/8",M10	15	45
1701 MTB 100	100	25	128	35	3/8",M10	15	55

MTB MOBLEN KASNAK ÜZERİ TERMOELASTİK KAPLAMA BURÇLU









KOD NO	mm	mm	mm	mm	mm	mm	kg	
1701 MTB 050 F18	50	20	75.5	27	74	3/8",M10	15	35
1701 MTB 075 F18	75	25	105	33	86	3/8",M10	15	45
1701 MTB 100 F18	100	25	128	28	98	3/8",M10	15	55











MTR		MOBLEN KASNAK ÜZERİ TERMOELASTİK KAPLAMA RULMANLI						
KOD NO	 mm	 mm	 mm	 mm	 mm	 mm	 kg	
1701 MTR 050	50	20	75.5	25	3/8",M10	15	35	
1701 MTR 075	75	25	105	31	3/8",M10	15	45	











MTR		MOBLEN KASNAK ÜZERİ TERMOELASTİK KAPLAMA RULMANLI						
KOD NO	 mm	 mm	 mm	 mm	 mm	 mm	 mm	 kg
1701 MTR 050 F18	50	20	75.5	25	74	3/8",M10	15	35
1701 MTR 075 F18	75	25	105	31	86	3/8",M10	15	45









PCR		POLİAMİD KASNAK ÜZERİ P.V.C. KAPLAMA RULMANLI						
KOD NO	 mm	 mm	 mm	 mm	 mm	 mm	 kg	
1701 PCR 100	100	25	126	35	3/8",M10	15	55	











PCR		POLİAMİD KASNAK ÜZERİ P.V.C. KAPLAMA RULMANLI						
KOD NO	 mm	 mm	 mm	 mm	 mm	 mm	 mm	 kg
1701 PCR 100 F18	100	25	128	28	98	3/8",M10	15	55









PPB		POLİAMİD TEKER BURÇLU						
KOD NO	 mm	 mm	 mm	 mm	 mm	 mm	 kg	
1701 PPB 050	50	20	75.5	25	3/8",M10	15	35	
1701 PPB 075	75	25	105	31	3/8",M10	15	45	
1701 PPB 100	100	25	128	35	3/8",M10	15	55	











PPB		POLİAMİD TEKER BURÇLU						
KOD NO	 mm	 mm	 mm	 mm	 mm	 mm	 mm	 kg
1701 PPB 050 F18	50	20	75.5	25	74	3/8",M10	15	35
1701 PPB 075 F18	75	25	105	31	86	3/8",M10	15	45
1701 PPB 100 F18	100	25	128	35	98	3/8",M10	15	55



HCB		POLİKARBONAT KASNAK ÜZERİ P.V.C. KAPLAMA BURÇLU						
KOD NO	 mm	 mm	 mm	 mm	 mm	 mm	 kg	
1701 HCB 050	50	20	75.5	25	3/8",M10	15	35	
1701 HCB 075	75	25	105	31	3/8",M10	15	45	



HCB		POLİKARBONAT KASNAK ÜZERİ P.V.C. KAPLAMA BURÇLU						
KOD NO	 mm	 mm	 mm	 mm	 mm	 mm	 mm	 kg
1701 HCB 050 F18	50	20	75.5	27	74	3/8",M10	15	35
1701 HCB 075 F18	75	25	105	33	86	3/8",M10	15	45

- A:** BAĞLANTI CİVATASI
- B:** ALTIGEN PUL
- C:** ÜST BİLYA KAPAĞI
- D:** KÜRESEL METAL TANE BİLYALAR
- E:** OYNAK RULET MAŞASI
- F:** ALT BİLYA ÇANAĞI

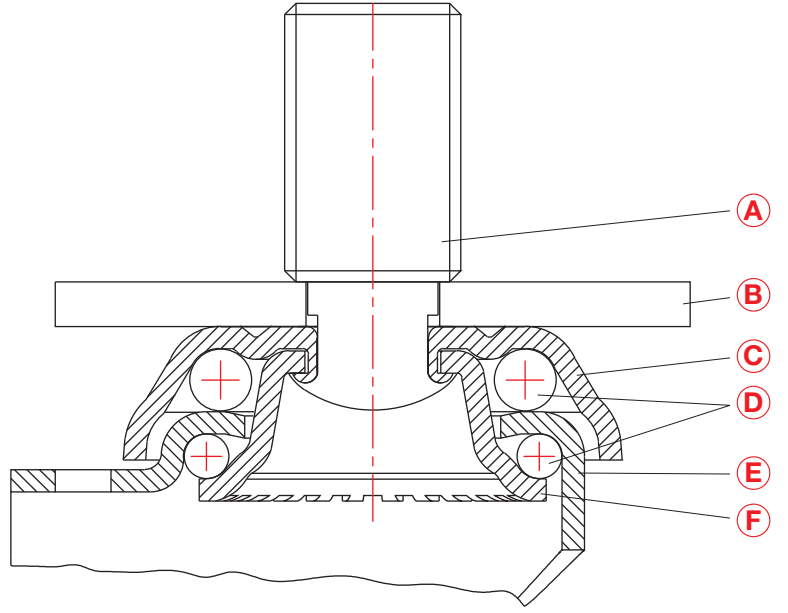

MMB		MOBLEN TEKER BURÇLU						
KOD NO	mm	mm	mm	mm	mm	mm	mm	kg
1701 MMB 100	100	25	126	35	5/8",M16	25		55



MMB		MOBLEN TEKER BURÇLU						
KOD NO	mm	mm	mm	mm	mm	mm	mm	kg
1701 MMB 100 F18	100	25	126	28	98	5/8",M16	25	55









MTB		MOBLEN KASNAK ÜZERİ TERMOELASTİK KAPLAMA BURÇLU						
KOD NO	mm	mm	mm	mm	mm	mm	mm	kg
1701 MTB 100	100	25	126	35	5/8",M16	25		55









MTB		MOBLEN KASNAK ÜZERİ TERMOELASTİK KAPLAMA BURÇLU						
KOD NO	mm	mm	mm	mm	mm	mm	mm	kg
1701 MTB 100 F18	100	25	126	28	98	5/8",M16	25	55









PCR		POLİAMİD KASNAK ÜZERİ P.V.C. KAPLAMA RULMANLI						
KOD NO								
	mm	mm	mm	mm	mm	mm	kg	
1701 PCR 100	100	25	126	35	5/8",M16	25	55	









PCR		POLİAMİD KASNAK ÜZERİ P.V.C. KAPLAMA RULMANLI						
KOD NO								
	mm	mm	mm	mm	mm	mm	kg	
1701 PCR 100 F18	100	25	126	28	98	5/8",M16	25	55



PPB		POLİAMİD TEKER BURÇLU						
KOD NO								
	mm	mm	mm	mm	mm	mm	kg	
1701 PPB 100	100	25	126	35	5/8",M16	25	55	



PPB		POLİAMİD TEKER BURÇLU						
KOD NO								
	mm	mm	mm	mm	mm	mm	kg	
1701 PPB 100 F18	100	25	126	28	98	5/8",M16	25	55

050'LİK TABLA

075'LİK TABLA

- A:** TABLA BAĞLANTI PERÇİNİ
- B:** OYNAK BAĞLANTI TABLASI
- C:** ÜST BİLYA KAPAĞI
- D:** KÜRESEL METAL TANE BİLYALAR
- E:** OYNAK RULET MAŞASI
- F:** ALT BİLYA ÇANAĞI

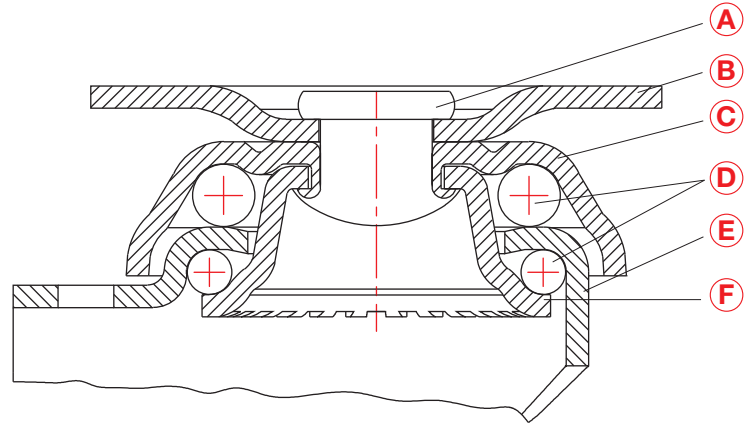
MMB
MOBLEN TEKER BURÇLU

KOD NO	mm	mm	mm	mm	mm	mm	mm	kg
1702 MMB 050	50	20	75.5	25	50x50	28x28	6.5	35
1702 MMB 075	75	25	105	31	60x60	43x43	6.5	45
1702 MMB 100	100	25	128	35	60x60	49x49	11x6.5	55

MMB
MOBLEN TEKER BURÇLU

KOD NO	mm	mm	mm	mm	mm	mm	mm	kg	
1702 MMB 050 F18	50	20	75.5	25	74	50x50	28x28	6.5	35
1702 MMB 075 F18	75	25	105	31	88	60x60	43x43	6.5	45
1702 MMB 100 F18	100	25	128	35	95	60x60	49x49	11x6.5	55

MTB
MOBLEN KASNAK ÜZERİ TERMOELASTİK KAPLAMA BURÇLU

KOD NO	mm	mm	mm	mm	mm	mm	mm	kg
1702 MTB 050	50	20	75.5	25	50x50	28x28	6.5	35
1702 MTB 075	75	25	105	31	60x60	43x43	6.5	45
1702 MTB 100	100	25	128	35	60x60	49x49	11x6.5	55

MTB
MOBLEN KASNAK ÜZERİ TERMOELASTİK KAPLAMA BURÇLU

KOD NO	mm	mm	mm	mm	mm	mm	mm	kg	
1702 MTB 050 F18	50	20	75.5	25	74	50x50	28x28	6.5	35
1702 MTB 075 F18	75	25	105	31	88	60x60	43x43	6.5	45
1702 MTB 100 F18	100	25	128	35	95	60x60	49x49	11x6.5	55



MTR		MOBLEN KASNAK ÜZERİ TERMOELASTİK KAPLAMA RULMANLI						
KOD NO								
	mm	mm	mm	mm	mm	mm	mm	kg
1702 MTR 050	50	20	75.5	25	50x50	28x28	6.5	35
1702 MTR 075	75	25	105	31	60x60	43x43	6.5	45



MTR		MOBLEN KASNAK ÜZERİ TERMOELASTİK KAPLAMA RULMANLI							
KOD NO									
	mm	mm	mm	mm	mm	mm	mm	kg	
1702 MTR 050 F18	50	20	75.5	27	74	50x50	28x28	6.5	35
1702 MTR 075 F18	75	25	105	33	88	60x60	43x43	6.5	45



PCR		POLİAMİD KASNAK ÜZERİ P.V.C. KAPLAMA RULMANLI						
KOD NO								
	mm	mm	mm	mm	mm	mm	mm	kg
1702 PCR 100	100	25	128	35	60x60	49x49	11x6.5	55



PCR		POLİAMİD KASNAK ÜZERİ P.V.C. KAPLAMA RULMANLI							
KOD NO									
	mm	mm	mm	mm	mm	mm	mm	kg	
1702 PCR 100 F18	100	25	128	28	95	60x60	49x49	11x6.5	55











PPB		POLİAMİD TEKER BURÇLU						
KOD NO								
	mm	mm	mm	mm	mm	mm	mm	kg
1702 PPB 050	50	20	75.5	25	50x50	28x28	6.5	35
1702 PPB 075	75	25	105	31	60x60	43x43	6.5	45
1702 PPB 100	100	25	128	35	60x60	49x49	11x6.5	55











PPB		POLİAMİD TEKER BURÇLU							
KOD NO									
	mm	mm	mm	mm	mm	mm	mm	kg	
1702 PPB 050 F18	50	20	75.5	27	74	50x50	28x28	6.5	35
1702 PPB 075 F18	75	25	105	33	88	60x60	43x43	6.5	45
1702 PPB 100 F18	100	25	128	28	95	60x60	49x49	11x6.5	55



HCB		POLİKARBONAT KASNAK ÜZERİ P.V.C. KAPLAMA BURÇLU						
KOD NO	 mm	 mm	 mm	 mm	 mm	 mm	 mm	 kg
1702 HCB 050	50	20	75.5	25	50x50	28x28	6.5	35
1702 HCB 075	75	25	105	31	60x60	43x43	6.5	45



HCB		POLİKARBONAT KASNAK ÜZERİ P.V.C. KAPLAMA BURÇLU							
KOD NO	 mm	 mm	 mm	 mm	 mm	 mm	 mm	 kg	
1702 HCB 050 F18	50	20	75.5	27	74	50x50	28x28	6.5	35
1702 HCB 075 F18	75	25	105	33	88	60x60	43x43	6.5	45

- A:** BAĞLANTI PİMİ
B: ÜST BİLYA KAPAĞI
C: KÜRESEL METAL TANE BİLYALAR
D: OYNAK RULET MAŞASI
E: ALT BİLYA KAPAĞI

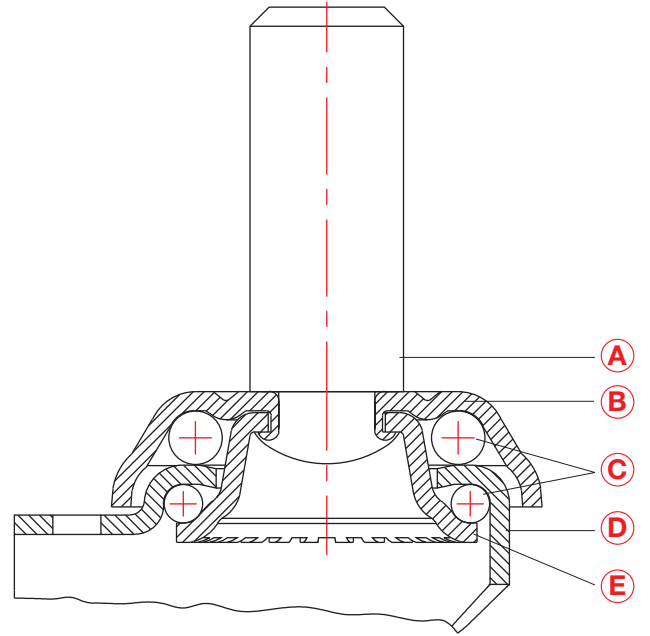

MMB		MOBLEN TEKER BURÇLU						
KOD NO	mm	mm	mm	mm	mm	mm	kg	
1705 MMB 050	50	20	71	25	16	40	35	
1705 MMB 075	75	25	97	31	19	40	45	
1705 MMB 100	100	25	122	35	22	40	55	



MMB		MOBLEN TEKER BURÇLU						
KOD NO	mm	mm	mm	mm	mm	mm	kg	
1705 MMB 050 F18	50	20	71	27	74	16	35	
1705 MMB 075 F18	75	25	97	33	82	19	45	
1705 MMB 100 F18	100	25	122	28	82	22	55	











MTB		MOBLEN KASNAK ÜZERİ TERMOELASTİK KAPLAMA BURÇLU						
KOD NO	mm	mm	mm	mm	mm	mm	kg	
1705 MTB 050	50	20	71	25	16	40	35	
1705 MTB 075	75	25	97	31	19	40	45	
1705 MTB 100	100	25	122	35	22	40	55	











MTB		MOBLEN KASNAK ÜZERİ TERMOELASTİK KAPLAMA BURÇLU						
KOD NO	mm	mm	mm	mm	mm	mm	kg	
1705 MTB 050 F18	50	20	71	25	74	16	35	
1705 MTB 075 F18	75	25	97	31	82	19	45	
1705 MTB 100 F18	100	25	122	35	82	22	55	











MTR		MOBLEN KASNAK ÜZERİ TERMOELASTİK KAPLAMA RULMANLI						
KOD NO								
	mm	mm	mm	mm	mm	mm	mm	kg
1705 MTR 050	50	20	71	25	16	40		35
1705 MTR 075	75	25	97	31	19	40		45











MTR		MOBLEN KASNAK ÜZERİ TERMOELASTİK KAPLAMA RULMANLI						
KOD NO								
	mm	mm	mm	mm	mm	mm	mm	kg
1705 MTR 050 F18	50	20	71	25	74	16	40	35
1705 MTR 075 F18	75	25	97	31	82	19	40	45











PCR		POLİAMİD KASNAK ÜZERİ P.V.C. KAPLAMA RULMANLI						
KOD NO								
	mm	mm	mm	mm	mm	mm	mm	kg
1705 PCR 100	100	25	122	31	22	40		55











PCR		POLİAMİD KASNAK ÜZERİ P.V.C. KAPLAMA RULMANLI						
KOD NO								
	mm	mm	mm	mm	mm	mm	mm	kg
1705 PCR 100 F18	100	25	122	28	82	22	40	55











PPB		POLİAMİD TEKER BURÇLU						
KOD NO								
	mm	mm	mm	mm	mm	mm	mm	kg
1705 PPB 050	50	20	71	25	16	40		35
1705 PPB 075	75	25	97	31	19	40		45
1705 PPB 100	100	25	122	35	22	40		55











PPB		POLİAMİD TEKER BURÇLU						
KOD NO								
	mm	mm	mm	mm	mm	mm	mm	kg
1705 PPB 050 F18	50	20	71	27	74	16	40	35
1705 PPB 075 F18	75	25	97	33	82	19	40	45
1705 PPB 100 F18	100	25	122	28	82	22	40	55



HCB		POLİKARBONAT KASNAK ÜZERİ P.V.C. KAPLAMA BURÇLU						
KOD NO	 mm	 mm	 mm	 mm	 mm	 mm	 mm	 kg
1705 HCB 050	50	20	71	25	16	40	35	
1705 HCB 075	75	25	97	31	19	40	45	





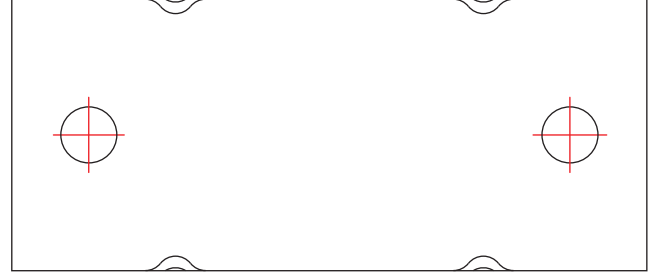

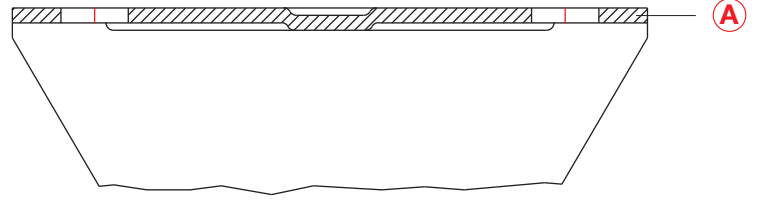

HCB		POLİKARBONAT KASNAK ÜZERİ P.V.C. KAPLAMA BURÇLU						
KOD NO	 mm	 mm	 mm	 mm	 mm	 mm	 mm	 kg
1705 HCB 050 F18	50	20	71	27	74	16	40	35
1705 HCB 075 F18	75	25	97	33	82	19	40	45









A: SABİT MAŞA







**MMB****MOBLEN TEKER BURÇLU**

KOD NO	 mm	 mm	 mm	 mm	 mm	 mm	 kg
1707 MMB 050	50	20	68	68x28	50	6	35
1707 MMB 075	75	25	93	85x37	63	9	45
1707 MMB 100	100	25	120	87x37	63	9	55





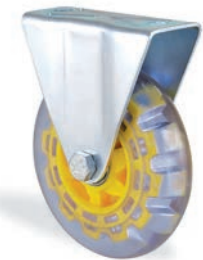

**MTB****MOBLEN KASNAK ÜZERİ TERMOELASTİK KAPLAMA BURÇLU**

KOD NO	 mm	 mm	 mm	 mm	 mm	 mm	 kg
1707 MTB 050	50	20	68	68x28	50	6	35
1707 MTB 075	75	25	93	85x37	63	9	45
1707 MTB 100	100	25	120	87x37	63	9	55







**MTR****MOBLEN KASNAK ÜZERİ TERMOELASTİK KAPLAMA RULMANLI**

KOD NO	 mm	 mm	 mm	 mm	 mm	 mm	 kg
1707 MTR 050	50	20	68	68x28	50	6	35
1707 MTR 075	75	25	93	85x37	63	9	45



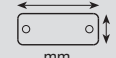



**PCR****MOBLEN KASNAK ÜZERİ TERMOELASTİK KAPLAMA RULMANLI**

KOD NO	 mm	 mm	 mm	 mm	 mm	 mm	 kg
1707 PCR 100	100	25	120	87x37	63	9	55

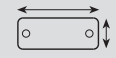

PPB		POLİAMİD TEKER BURÇLU						
KOD NO	 mm	 mm	 mm	 mm	 mm	 mm	 kg	
1707 PPB 050	50	20	68	68x28	50	6	35	
1707 PPB 075	75	25	93	85x37	63	9	45	
1707 PPB 100	100	25	120	87x37	63	9	55	

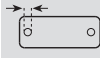

HCB		POLİKARBONAT KASNAK ÜZERİ P.V.C. KAPLAMA BURÇLU						
KOD NO	 mm	 mm	 mm	 mm	 mm	 mm	 kg	
1707 HCB 050	50	20	68	68x28	50	6	35	
1707 HCB 075	75	25	93	85x37	63	9	45	



YUVARLAK SOKET



KARE SOKET

- A:** OYNAK RULET MAŞASI
- B:** ALT BİLYA ÇANAĞI
- C:** KÜRESEL METAL TANE BİLYALAR
- D:** ÜST BİLYA KAPAĞI
- E:** SOKET VE SOMUN ALTI TAKVİYELİ PLASTİK
- F:** SOKET
- G:** KARE SOMUN
- H:** İMBUS CİVATA

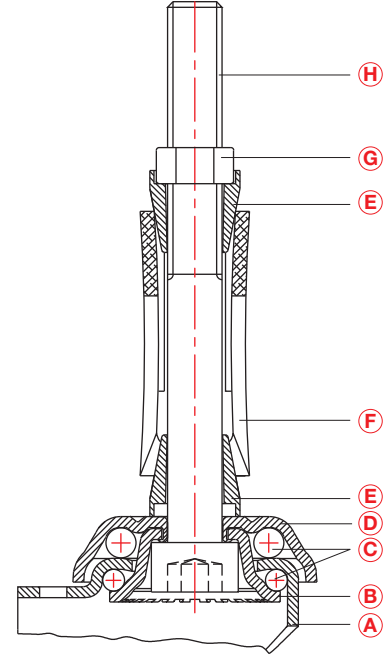

MMB MOBLEN TEKER BURÇLU

KOD NO	mm	mm	mm	mm	mm	kg
1725 MMB 050	50	20	71	25	81	35
1725 MMB 075	75	25	97	31	81	45
1725 MMB 100	100	25	122	35	81	55

MMB MOBLEN TEKER BURÇLU

KOD NO	mm	mm	mm	mm	mm	kg
1725 MMB 050 F18	50	20	71	27	74	35
1725 MMB 075 F18	75	25	97	33	82	45
1725 MMB 100 F18	100	25	122	28	82	55







MTB MOBLEN KASNAK ÜZERİ TERMOELASTİK KAPLAMA BURÇLU

KOD NO	mm	mm	mm	mm	mm	kg
1725 MTB 050	50	20	71	25	81	35
1725 MTB 075	75	25	97	31	81	45
1725 MTB 100	100	25	122	35	81	55







MTB MOBLEN KASNAK ÜZERİ TERMOELASTİK KAPLAMA BURÇLU

KOD NO	mm	mm	mm	mm	mm	kg
1725 MTB 050 F18	50	20	71	27	74	35
1725 MTB 075 F18	75	25	97	33	82	45
1725 MTB 100 F18	100	25	122	28	82	55









MTR		MOBLEN KASNAK ÜZERİ TERMOELASTİK KAPLAMA RULMANLI					
KOD NO							
	mm	mm	mm	mm	mm	kg	
1725 MTR 050	50	20	71	25	81	35	
1725 MTR 075	75	25	97	31	81	45	









MTR		MOBLEN KASNAK ÜZERİ TERMOELASTİK KAPLAMA RULMANLI					
KOD NO							
	mm	mm	mm	mm	mm	mm	kg
1725 MTR 050 F18	50	20	71	27	74	81	35
1725 MTR 075 F18	75	25	97	33	82	81	45









PCR		POLİAMİD KASNAK ÜZERİ P.V.C. KAPLAMA RULMANLI					
KOD NO							
	mm	mm	mm	mm	mm	kg	
1725 PCR 100	100	25	122	35	81	55	









PCR		POLİAMİD KASNAK ÜZERİ P.V.C. KAPLAMA RULMANLI					
KOD NO							
	mm	mm	mm	mm	mm	mm	kg
1725 PCR 100 F18	100	25	122	28	82	81	55









PPB		POLİAMİD TEKER BURÇLU					
KOD NO							
	mm	mm	mm	mm	mm	kg	
1725 PPB 050	50	20	71	25	81	35	
1725 PPB 075	75	25	97	31	81	45	
1725 PPB 100	100	25	122	35	81	55	









PPB		POLİAMİD TEKER BURÇLU					
KOD NO							
	mm	mm	mm	mm	mm	mm	kg
1725 PPB 050 F18	50	20	71	27	74	81	35
1725 PPB 075 F18	75	25	97	33	82	81	45
1725 PPB 100 F18	100	25	122	28	82	81	55



HCB		POLİKARBONAT KASNAK ÜZERİ P.V.C. KAPLAMA BURÇLU					
KOD NO	 mm	 mm	 mm	 mm	 mm	 kg	
1725 HCB 050	50	20	71	25	81	35	
1725 HCB 075	75	25	97	31	81	45	



HCB		POLİKARBONAT KASNAK ÜZERİ P.V.C. KAPLAMA BURÇLU					
KOD NO	 mm	 mm	 mm	 mm	 mm	 mm	 kg
1725 HCB 050 F18	50	20	71	27	74	81	35
1725 HCB 075 F18	75	25	97	33	82	81	45

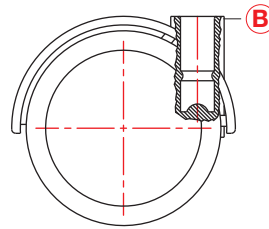

1800-S1800

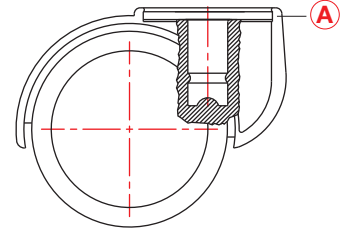

G 1800

A: POLİAMİD GÖVDE

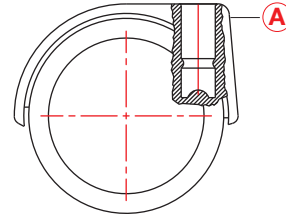
B: MOBLEN / POLİAMİD GÖVDE

M1800

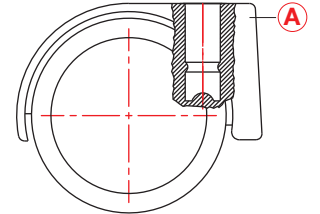

Z 1800



PPB		POLİAMİD TEKER BURÇLU						
KOD NO								
	mm	mm	mm	mm	mm	mm	kg	
G1800 PPB 050	50	2x12	42	54	20	8.5	40	
G1800 PPB 050 F02	50	2x12	42	54	20	8.5	40	



PUB		POLİAMİD KASNAK ÜZERİ POLİÜRETAN KAPLAMA BURÇLU						
KOD NO								
	mm	mm	mm	mm	mm	mm	kg	
G1800 PUB 050	50	2x12	42	54	20	8.5	40	
G1800 PUB 050 F02	50	2x12	42	54	20	8.5	40	









PPB		POLİAMİD TEKER BURÇLU						
KOD NO								
	mm	mm	mm	mm	mm	mm	kg	
M1800 PPB 050	50	2x12	42	55.5	20	8.5	40	
M1800 PPB 050 F02	50	2x12	42	55.5	20	8.5	40	









PPB		POLİAMİD TEKER BURÇLU						
KOD NO								
	mm	mm	mm	mm	mm	mm	kg	
M1800 PPB 050 F01	50	2x12	42	55.5	20	65.5	8.5	40









PUB		POLİAMİD KASNAK ÜZERİ POLİÜRETAN KAPLAMA BURÇLU						
KOD NO								
	mm	mm	mm	mm	mm	mm	kg	
M1800 PUB 050	50	2x12	42	55.5	20	8.5	40	
M1800 PUB 050 F02	50	2x12	42	55.5	20	8.5	40	









MMB		MOBLEN TEKER BURÇLU						
KOD NO								
	mm	mm	mm	mm	mm	mm	kg	
1800 MMB 035	35	2x6	27	40	13	7	15	
1800 MMB 040	40	2x8	32	46	14	7.2	20	









MMB		MOBLEN TEKER BURÇLU						
KOD NO								
	mm	mm	mm	mm	mm	mm	kg	
S1800 MMB 050	50	2x12	42	54	20	8.5	40	









MMB		MOBLEN TEKER BURÇLU						
KOD NO								
	mm	mm	mm	mm	mm	mm	kg	
S1800 MMB 050 F01	50	2x12	42	54	20	56	8.5	40



PPB		POLİAMİD TEKER BURÇLU						
KOD NO								
	mm	mm	mm	mm	mm	mm	kg	
S1800 PPB 050	50	2x12	42	54	20	8.5	40	









PPB		POLİAMİD TEKER BURÇLU						
KOD NO								
	mm	mm	mm	mm	mm	mm	kg	
S1800 PPB 050 F01	50	2x12	42	56	20	56	8.5	40









PUB		POLİAMİD KASNAK ÜZERİ POLİÜRETAN KAPLAMA BURÇLU						
KOD NO								
	mm	mm	mm	mm	mm	mm	kg	
S1800 PUB 050	50	2x12	42	54	20	8.5	40	



PPB		POLİAMİD TEKER BURÇLU						
KOD NO								
	mm	mm	mm	mm	mm	mm	kg	
Z1800 PPB 050	50	2x12	42	54	20	8.5	40	





PPB		POLİAMİD TEKER BURÇLU (KROM KAPLI ZAMAK GÖVDE)						
KOD NO								
	mm	mm	mm	mm	mm	mm	kg	
Z1800 PPB 050 KR	50	2x12	42	55	20	8.5	40	
Z1800 PPB 050 F02 KR	50	2x12	42	55	20	8.5	40	







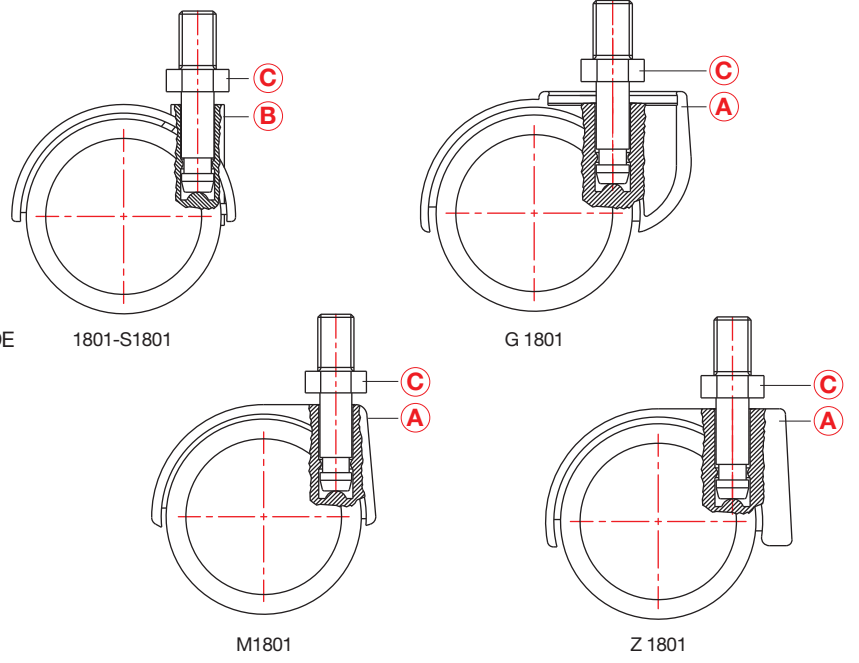

PUB		POLİAMİD KASNAK ÜZERİ POLİÜRETAN KAPLAMA BURÇLU						
KOD NO								
	mm	mm	mm	mm	mm	mm	kg	
Z1800 PUB 050	50	2x12	42	54	20	8.5	40	









PUB		POLİAMİD KASNAK ÜZERİ POLİÜRETAN KAPLAMA BURÇLU (KROM KAPLI ZAMAK GÖVDE)						
KOD NO								
	mm	mm	mm	mm	mm	mm	kg	
Z1800 PUB 050 KR	50	2x12	42	55	20	8.5	40	
Z1800 PUB 050 F02 KR	50	2x12	42	55	20	8.5	40	









PPB POLİAMİD TEKER BURÇLU

KOD NO	 mm	 mm	 mm	 mm	 mm	 mm	 mm	kg
G1801 PPB 050	50	2x12	42	65.5	20	3/8",M10	15	40
G1801 PPB 050 F02	50	2x12	42	65.5	20	3/8",M10	15	40







PUB POLİAMİD KASNAK ÜZERİ POLİÜRETAN KAPLAMA BURÇLU

KOD NO	 mm	 mm	 mm	 mm	 mm	 mm	 mm	kg
G1801 PUB 050	50	2x12	42	65.5	20	3/8",M10	15	40
G1801 PUB 050 F02	50	2x12	42	65.5	20	3/8",M10	15	40

PPB POLİAMİD TEKER BURÇLU

KOD NO	 mm	 mm	 mm	 mm	 mm	 mm	 mm	kg
M1801 PPB 050	50	2x12	42	64.5	20	3/8",M10	15	40
M1801 PPB 050 F02	50	2x12	42	64.5	20	3/8",M10	15	40

PPB POLİAMİD TEKER BURÇLU

KOD NO	 mm	 mm	 mm	 mm	 mm	 mm	 mm	kg	
M1801 PPB 050 F01	50	2x12	42	64.5	20	65.5	3/8",M10	15	40



PUB		POLİAMİD KASNAK ÜZERİ POLİÜRETAN KAPLAMA BURÇLU							
KOD NO									
	mm	mm	mm	mm	mm	mm	mm	kg	
M1801 PUB 050	50	2x12	42	64.5	20	3/8",M10	15	40	
M1801 PUB 050 F02	50	2x12	42	64.5	20	3/8",M10	15	40	



MMB		MOBLEN TEKER BURÇLU							
KOD NO									
	mm	mm	mm	mm	mm	mm	mm	kg	
1801 MMB 035	35	2x6	27	46.5	13	5/16"	13.5	15	
1801 MMB 040	40	2x8	32	52.5	14	5/16"	13.5	20	



MMB		MOBLEN TEKER BURÇLU							
KOD NO									
	mm	mm	mm	mm	mm	mm	mm	kg	
S1801 MMB 050	50	2x12	42	63	20	3/8",M10	15	40	



MMB		MOBLEN TEKER BURÇLU							
KOD NO									
	mm	mm	mm	mm	mm	mm	mm	kg	
S1801 MMB 050 F01	50	2x12	42	63	20	56.5	3/8",M10	15	40









PPB		POLİAMİD TEKER BURÇLU							
KOD NO									
	mm	mm	mm	mm	mm	mm	mm	kg	
S1801 PPB 050	50	2x12	42	63	20	3/8",M10	15	40	











PPB		POLİAMİD TEKER BURÇLU							
KOD NO									
	mm	mm	mm	mm	mm	mm	mm	kg	
S1801 PPB 050 F01	50	2x12	42	65	20	56.5	3/8",M10	15	40











PUB		POLİAMİD KASNAK ÜZERİ POLİÜRETAN KAPLAMA BURÇLU						
KOD NO								
	mm	mm	mm	mm	mm	mm	mm	kg
S1801 PUB 050	50	2x12	42	63	20	3/8",M10	15	40



PPB		POLİAMİD TEKER BURÇLU						
KOD NO								
	mm	mm	mm	mm	mm	mm	mm	kg
Z1801 PPB 050	50	2x12	42	63	20	3/8",M10	15	40











PPB		POLİAMİD TEKER BURÇLU (KROM KAPLI ZAMAK GÖVDE)						
KOD NO								
	mm	mm	mm	mm	mm	mm	mm	kg
Z1801 PPB 050 KR	50	2x12	42	63	20	3/8",M10	15	40
Z1801 PPB 050 F02 KR	50	2x12	42	63	20	3/8",M10	15	40



PUB		POLİAMİD KASNAK ÜZERİ POLİÜRETAN KAPLAMA BURÇLU						
KOD NO								
	mm	mm	mm	mm	mm	mm	mm	kg
Z1801 PUB 050	50	2x12	42	63	20	3/8",M10	15	40



PUB		POLİAMİD KASNAK ÜZERİ POLİÜRETAN KAPLAMA BURÇLU (KROM KAPLI ZAMAK GÖVDE)						
KOD NO								
	mm	mm	mm	mm	mm	mm	mm	kg
Z1801 PUB 050 KR	50	2x12	42	63	20	3/8",M10	15	40
Z1801 PUB 050 F02 KR	50	2x12	42	63	20	3/8",M10	15	40

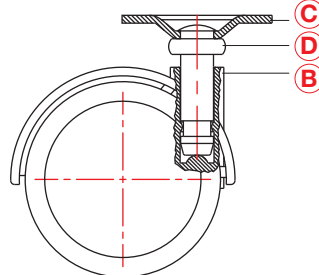

1802-S1802

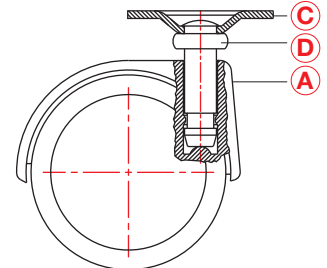

M1802

- A:** POLİAMİD GÖVDE
B: MOBLEN / POLİAMİD GÖVDE
C: OYNAK TABLA
D: BAĞLANTI PERÇİNİ

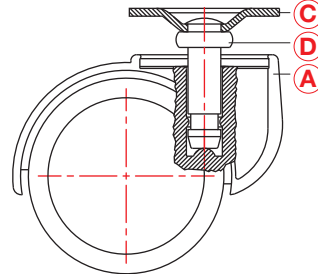

G 1802

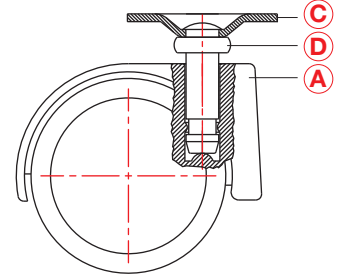

Z 1802



PPB		POLİAMİD TEKER BURÇLU								
KOD NO										
	mm	mm	mm	mm	mm	mm	mm	mm	kg	
M1802 PPB 050	50	2x12	42	68.5	20	38.5x38.5	27x27	5	40	
M1802 PPB 050 F02	50	2x12	42	68.5	20	38.5x38.5	27x27	5	40	



PPB		POLİAMİD TEKER BURÇLU								
KOD NO										
	mm	mm	mm	mm	mm	mm	mm	mm	mm	kg
M1802 PPB 050 F01	50	2x12	42	68.5	65.5	20	38.5x38.5	27x27	5	40











PUB		POLİAMİD KASNAK ÜZERİ POLİÜRETAN KAPLAMA BURÇLU								
KOD NO										
	mm	mm	mm	mm	mm	mm	mm	mm	mm	kg
M1802 PUB 050	50	2x12	42	68.5	20	38.5x38.5	27x27	5	40	
M1802 PUB 050 F02	50	2x12	42	68.5	20	38.5x38.5	27x27	5	40	











MMB		MOBLEN TEKER BURÇLU								
KOD NO										
	mm	mm	mm	mm	mm	mm	mm	mm	kg	
1802 MMB 035	35	2x6	27	46.5	13	38.5x38.5	27x27	5	15	
1802 MMB 040	40	2x8	32	52.5	14	38.5x38.5	27x27	5	20	











MMB		MOBLEN TEKER BURÇLU								
KOD NO										kg
S1802 MMB 050	50	2x12	42	67.5	20	38.5x38.5	27x27	5	40	











MMB		MOBLEN TEKER BURÇLU								
KOD NO										kg
S1802 MMB 050 F01	50	2x12	42	69.5	56.3	20	38.5x38.5	27x27	5	40



PPB		POLİAMİD TEKER BURÇLU								
KOD NO										kg
S1802 PPB 050	50	2x12	42	67.5	20	38.5x38.5	27x27	5	40	











PPB		POLİAMİD TEKER BURÇLU								
KOD NO										kg
S1802 PPB 050 F01	50	2x12	42	69.5	56.3	20	38.5x38.5	27x27	5	40







PUB		POLİAMİD KASNAK ÜZERİ POLİÜRETAN KAPLAMA BURÇLU								
KOD NO										kg
S1802 PUB 050	50	2x12	42	67.5	20	38.5x38.5	27x27	5	40	



PPB		POLİAMİD TEKER BURÇLU								
KOD NO										kg
Z1802 PPB 050	50	2x12	42	66.5	20	38.5x38.5	27x27	5	40	











PPB		POLİAMİD TEKER BURÇLU (KROM KAPLI ZAMAK GÖVDE)								
KOD NO	 mm	 mm	 mm	 mm	 mm	 mm	 mm	 mm	 kg	
Z1802 PPB 050 KR	50	2x12	42	67.5	20	38.5x38.5	27x27	5	40	
Z1802 PPB 050 F02 KR	50	2x12	42	67.5	20	38.5x38.5	27x27	5	40	



PUB		POLİAMİD KASNAK ÜZERİ POLİÜRETAN KAPLAMA BURÇLU								
KOD NO	 mm	 mm	 mm	 mm	 mm	 mm	 mm	 mm	 kg	
Z1802 PUB 050	50	2x12	42	66.5	20	38.5x38.5	27x27	5	40	



PUB		POLİAMİD KASNAK ÜZERİ POLİÜRETAN KAPLAMA BURÇLU (KROM KAPLI ZAMAK GÖVDE)								
KOD NO	 mm	 mm	 mm	 mm	 mm	 mm	 mm	 mm	 kg	
Z1802 PUB 050 KR	50	2x12	42	67.5	20	38.5x38.5	27x27	5	40	
Z1802 PUB 050 F02 KR	50	2x12	42	67.5	20	38.5x38.5	27x27	5	40	

YUVARLAK BAŞLIK

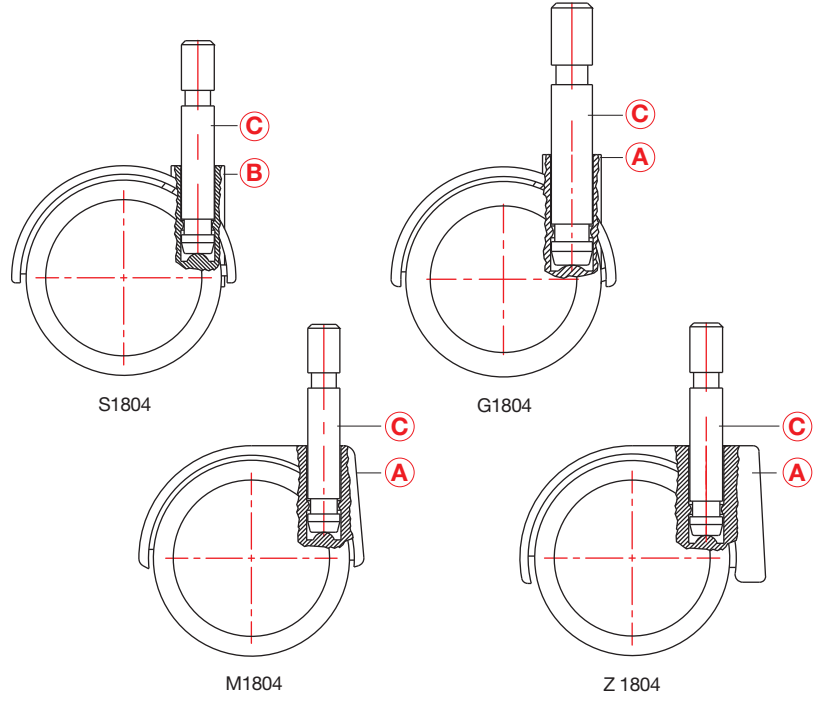
KARE BAŞLIK











PPB		POLİAMİD TEKER BURÇLU							
KOD NO									kg
M1804 PPB 050	50	2x12	42	55.5	20	8.4	31	40	
M1804 PPB 050 F02	50	2x12	42	55.5	20	8.4	31	40	

PPB		POLİAMİD TEKER BURÇLU							
KOD NO									kg
M1804 PPB 050 F01	50	2x12	42	55.5	20	56.5	8.4	31	40









PUB		POLİAMİD KASNAK ÜZERİ POLİÜRETAN KAPLAMA BURÇLU							
KOD NO									kg
M1804 PUB 050	50	2x12	42	55.5	20	8.4	31	40	
M1804 PUB 050 F02	50	2x12	42	55.5	20	8.4	31	40	

MMB		MOBLEN TEKER BURÇLU							
KOD NO									kg
S1804 MMB 050	50	2x12	42	55.5	20	8.4	31	40	











MMB		MOBLEN TEKER BURÇLU							
KOD NO									
	mm	mm	mm	mm	mm	mm	mm	mm	kg
S1804 MMB 050 F01	50	2x12	42	55.5	20	56.5	8.4	31	40



PPB		POLİAMİD TEKER BURÇLU							
KOD NO									
	mm	mm	mm	mm	mm	mm	mm	mm	kg
S1804 PPB 050	50	2x12	42	55.5	20	56.5	8.4	31	40











PPB		POLİAMİD TEKER BURÇLU							
KOD NO									
	mm	mm	mm	mm	mm	mm	mm	mm	kg
S1804 PPB 050 F01	50	2x12	42	55.5	20	56.5	8.4	31	40











PUB		POLİAMİD KASNAK ÜZERİ POLİÜRETAN KAPLAMA BURÇLU							
KOD NO									
	mm	mm	mm	mm	mm	mm	mm	mm	kg
S1804 PUB 050	50	2x12	42	55.5	20	56.5	8.4	31	40









PPB		POLİAMİD TEKER BURÇLU							
KOD NO									
	mm	mm	mm	mm	mm	mm	mm	mm	kg
Z1804 PPB 050	50	2x12	42	55.5	20	56.5	8.4	31	40



PPB		POLİAMİD TEKER BURÇLU (KROM KAPLI ZAMAK GÖVDE)							
KOD NO									
	mm	mm	mm	mm	mm	mm	mm	mm	kg
Z1804 PPB 050 KR	50	2x12	42	55.5	20	56.5	8.4	31	40
Z1804 PPB 050 F02 KR	50	2x12	42	55.5	20	56.5	8.4	31	40



PUB		POLİAMİD KASNAK ÜZERİ POLİÜRETAN KAPLAMA BURÇLU						
KOD NO								
	mm	mm	mm	mm	mm	mm	mm	kg
Z1804 PUB 050	50	2x12	42	55.5	20	8.4	31	40



PUB		POLİAMİD KASNAK ÜZERİ POLİÜRETAN KAPLAMA BURÇLU (KROM KAPLI ZAMAK GÖVDE)						
KOD NO								
	mm	mm	mm	mm	mm	mm	mm	kg
Z1804 PUB 050 KR	50	2x12	42	55	20	8.4	31	40
Z1804 PUB 050 F02 KR	50	2x12	42	55	20	8.4	31	40

- A:** POLİAMİD GÖVDE
B: BAĞLANTI PİMİ
C: BAĞLANTI SEGMANI

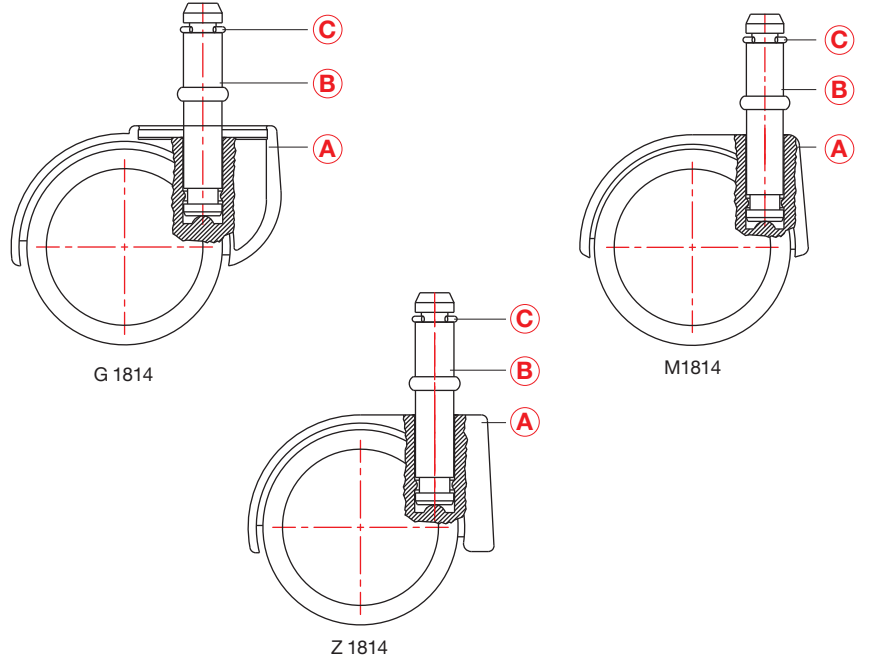

PPB		POLİAMİD TEKER BURÇLU						
KOD NO								
	mm	mm	mm	mm	mm	mm	mm	kg
G1814 PPB 050 Ø10	50	2x12	42	64	20	10	21.5	40
G1814 PPB 050 Ø11	50	2x12	42	64	20	11	19.5	40
G1814 PPB 050 F02 Ø10	50	2x12	42	64	20	10	21.5	40
G1814 PPB 050 F02 Ø11	50	2x12	42	64	20	11	19.5	40











PUB		POLİAMİD KASNAK ÜZERİ POLİÜRETAN KAPLAMA BURÇLU						
KOD NO								
	mm	mm	mm	mm	mm	mm	mm	kg
G1814 PUB 050 Ø10	50	2x12	42	64	20	10	21.5	40
G1814 PUB 050 Ø11	50	2x12	42	64	20	11	19.5	40
G1814 PUB 050 F02 Ø10	50	2x12	42	64	20	10	21.5	40
G1814 PUB 050 F02 Ø11	50	2x12	42	64	20	11	19.5	40











PPB		POLİAMİD TEKER BURÇLU						
KOD NO								
	mm	mm	mm	mm	mm	mm	mm	kg
M1814 PPB 050 Ø10	50	2x12	42	60	20	10	21.5	40
M1814 PPB 050 Ø11	50	2x12	42	60	20	11	19.5	40
M1814 PPB 050 F02 Ø10	50	2x12	42	60	20	10	21.5	40
M1814 PPB 050 F02 Ø11	50	2x12	42	60	20	11	19.5	40











PPB		POLİAMİD TEKER BURÇLU							
KOD NO									
	mm	mm	mm	mm	mm	mm	mm	mm	kg
M1814 PPB 050 F01 Ø10	50	2x12	42	60	20	65.5	10	21.5	40
M1814 PPB 050 F01 Ø11	50	2x12	42	60	20	65.5	11	19.5	40











PUB		POLİAMİD KASNAK ÜZERİ POLİÜRETAN KAPLAMA BURÇLU							
KOD NO									
	mm	mm	mm	mm	mm	mm	mm	mm	kg
M1814 PUB 050 Ø10	50	2x12	42	60	20	10	21.5	40	40
M1814 PUB 050 Ø11	50	2x12	42	60	20	11	19.5	40	40
M1814 PUB 050 F02 Ø10	50	2x12	42	60	20	10	21.5	40	40
M1814 PUB 050 F02 Ø11	50	2x12	42	60	20	11	19.5	40	40











PPB		POLİAMİD TEKER BURÇLU							
KOD NO									
	mm	mm	mm	mm	mm	mm	mm	mm	kg
Z1814 PPB 050 Ø10	50	2x12	42	60	20	10	21.5	40	40
Z1814 PPB 050 Ø11	50	2x12	42	60	20	11	19.5	40	40











PPB		POLİAMİD TEKER BURÇLU (KROM KAPLI ZAMAK GÖVDE)							
KOD NO									
	mm	mm	mm	mm	mm	mm	mm	mm	kg
Z1814 PPB 050 KR Ø10	50	2x12	42	60	20	10	21.5	40	40
Z1814 PPB 050 KR Ø11	50	2x12	42	60	20	11	19.5	40	40
Z1814 PPB 050 F02 KR Ø10	50	2x12	42	60	20	10	21.5	40	40
Z1814 PPB 050 F02 KR Ø11	50	2x12	42	60	20	11	19.5	40	40







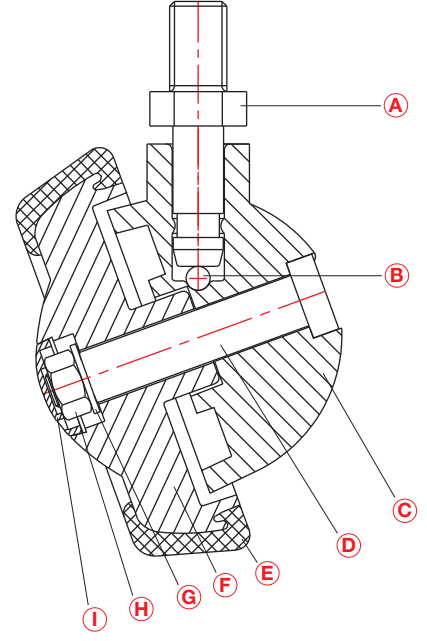

PUB		POLİAMİD KASNAK ÜZERİ POLİÜRETAN KAPLAMA BURÇLU							
KOD NO									
	mm	mm	mm	mm	mm	mm	mm	mm	kg
Z1814 PUB 050 Ø10	50	2x12	42	60	20	10	21.5	40	40
Z1814 PUB 050 Ø11	50	2x12	42	60	20	11	19.5	40	40

PUB POLİAMİD KASNAK ÜZERİ POLİÜRETAN KAPLAMA BURÇLU (KROM KAPLI ZAMAK GÖVDE)







KOD NO	 mm	 mm	 mm	 mm	 mm	 mm	 mm	 kg
Z1814 PUB 050 KR Ø10	50	2x12	42	60	20	10	21.5	40
Z1814 PUB 050 KR Ø11	50	2x12	42	60	20	11	19.5	40
Z1814 PUB 050 F02 KR Ø10	50	2x12	42	60	20	10	21.5	40
Z1814 PUB 050 F02 KR Ø11	50	2x12	42	60	20	11	19.5	40

- A:** BAĞLANTI CİVATASI
B: KÜRESEL METAL TANE BİLYA
C: POLİAMİD GÖVDE
D: GÖBEK MONTAJ CİVATASI
E: P.V.C. KILIF
F: POLİAMİD KASNAK
G: MONTAJ RONDELASI
H: M6 VURUŞLU SOMUN
I: SOMUN KAPAĞI







PPB POLİAMİD TEKER BURÇLU

KOD NO	 mm	 mm	 mm	 mm	 mm	 kg
2101 PPB 040	40	10.5	50	1/4	13	10
2101 PPB 050	50	13	59	3/8",M10	15	30
2101 PPB 060	60	14	70	3/8",M10	15	40







PCB POLİAMİD KASNAK ÜZERİ P.V.C. KAPLAMA BURÇLU

KOD NO	 mm	 mm	 mm	 mm	 mm	 kg
2101 PCB 070	70	18	79	3/8",M10	15	50
2101 PCB 090	90	19.5	107.5	M12	25	60

PUB POLİAMİD KASNAK ÜZERİ POLİÜRETAN KAPLAMA BURÇLU

KOD NO	 mm	 mm	 mm	 mm	 mm	 kg
2101 PUB 070	70	18	79	3/8",M10	15	50
2101 PUB 090	90	19.5	107.5	M12	25	60

MMB MOBLEN TEKER BURÇLU

KOD NO	 mm	 mm	 mm	 mm	 mm	 kg
2101 MMB 095	95	40	111	M12	25	90

040, 050'LİK TABLA

060-095'LİK TABLA

- A:** OYNAK TABLA
- B:** BAĞLANTI PERÇİNİ
- C:** MUHAFAZA TOZLUK
- D:** KÜRESEL METAL TANE BİLYA
- E:** POLİAMİD GÖVDE
- F:** GÖBEK MONTAJ CİVATASI
- G:** P.V.C. KILIF
- H:** POLİAMİD KASNAK
- I:** MONTAJ RONDELASI
- J:** M6 VURUŞLU SOMUN
- K:** SOMUN KAPAĞI

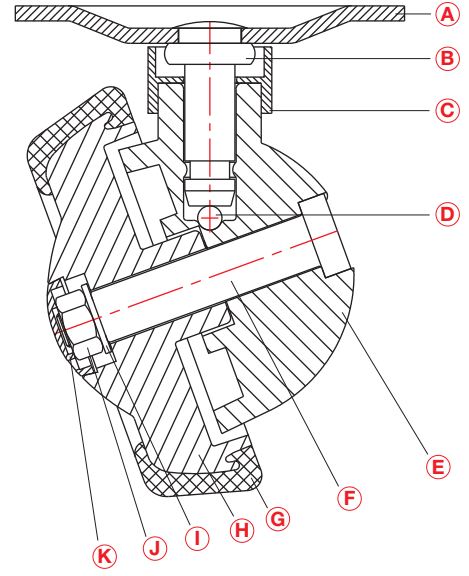
PPB POLİAMİD TEKER BURÇLU

KOD NO	mm	mm	mm	mm	mm	mm	kg
2102 PPB 040	40	10.5	53	27x27	18.5x18.5	4	10
2102 PPB 050	50	13	63	38x38	27x27	5	30
2102 PPB 060	60	14	81.5	64.5x64.5	47x47	6.5x12	40

PCB POLİAMİD KASNAK ÜZERİ P.V.C. KAPLAMA BURÇLU

KOD NO	mm	mm	mm	mm	mm	mm	kg
2102 PCB 070	70	18	82	64.5x64.5	47x47	6.5x12	50
2102 PCB 090	90	19.5	109	64.5x64.5	47x47	6.5x12	60

PUB POLİAMİD KASNAK ÜZERİ POLİÜRETAN KAPLAMA BURÇLU





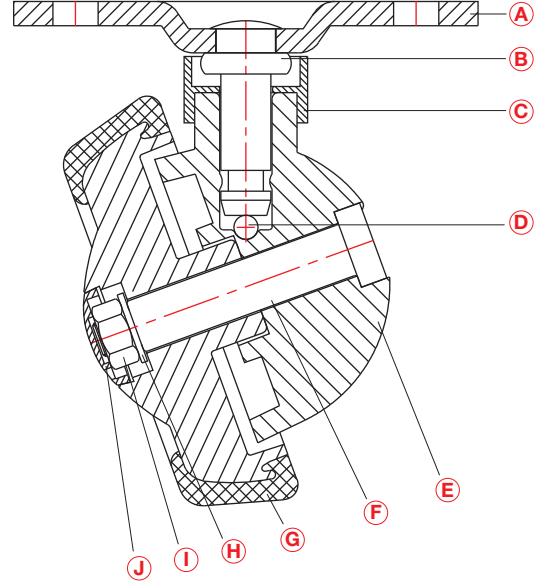

KOD NO	mm	mm	mm	mm	mm	mm	kg
2102 PUB 070	70	18	82	64.5x64.5	47x47	6.5x12	50
2102 PUB 090	90	19.5	109	64.5x64.5	47x47	6.5x12	60

MMB MOBLEN TEKER BURÇLU







KOD NO	mm	mm	mm	mm	mm	mm	kg
2102 MMB 095	95	40	113	64.5x64.5	47x47	6.5x12	90

- A:** OYNAK TABLA
B: BAĞLANTI PERÇİNİ
C: MUHAFAZA TOZLUK
D: KÜRESEL METAL TANE BİLYA
E: POLİAMİD GÖVDE
F: GÖBEK MONTAJ CİVATASI
G: P.V.C. KILIF
H: MONTAJ RONDELASI
I: M6 VURUŞLU SOMUN
J: SOMUN KAPAĞI









PPB		POLİAMİD TEKER BURÇLU						
KOD NO	 mm	 mm	 mm	 mm	 mm	 mm	 kg	
2103 PPB 060	60	14	84.5	77x38.5	56.5x22.5	7.5	40	









PCB		POLİAMİD KASNAK ÜZERİ P.V.C. KAPLAMA BURÇLU						
KOD NO	 mm	 mm	 mm	 mm	 mm	 mm	 kg	
2103 PCB 070	70	18	84	77x38.5	56.5x22.5	7.5	50	
2103 PCB 090	90	19.5	111.5	77x38.5	56.5x22.5	7.5	60	



PUB		POLİAMİD KASNAK ÜZERİ POLİÜRETAN KAPLAMA BURÇLU						
KOD NO	 mm	 mm	 mm	 mm	 mm	 mm	 kg	
2103 PUB 070	70	18	84	77x38.5	56.5x22.5	7.5	50	
2103 PUB 090	90	19.5	111.5	77x38.5	56.5x22.5	7.5	60	



MMB		MOBLEN TEKER BURÇLU						
KOD NO	 mm	 mm	 mm	 mm	 mm	 mm	 kg	
2103 MMB 095	95	40	115	77x38.5	56.5x22.5	7.5	90	

YUVARLAK BAŞLIK

KARE BAŞLIK

- A:** BAĞLANTI PİMİ
- B:** KÜRESEL METAL TANE BİLYA
- C:** POLİAMİD GÖVDE
- D:** GÖBEK MONTAJ CİVATASI
- E:** P.V.C. KILIF
- F:** POLİAMİD KASNAK
- G:** MONTAJ RONDELASI
- H:** M6 VURUŞLU SOMUN
- I:** SOMUN KAPAĞI

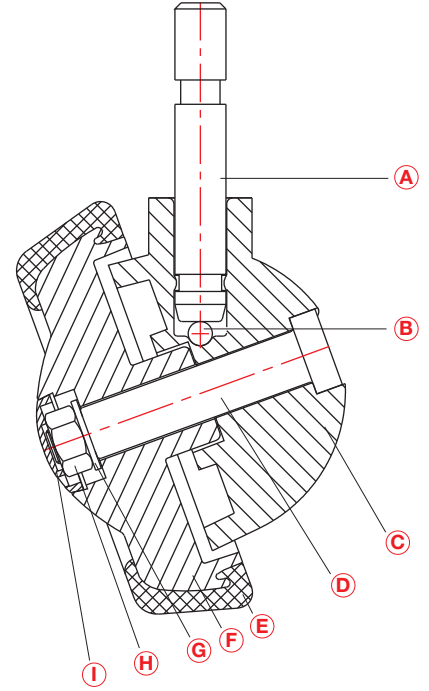
PPB POLİAMİD TEKER BURÇLU

KOD NO	mm	mm	mm	mm	mm	kg
2104 PPB 050	50	13	50	8.3	34	30
2104 PPB 060	60	14	68.5	8.3	34	40

PCB POLİAMİD KASNAK ÜZERİ P.V.C. KAPLAMA BURÇLU

KOD NO	mm	mm	mm	mm	mm	kg
2104 PCB 070	70	18	68	8.3	33	50





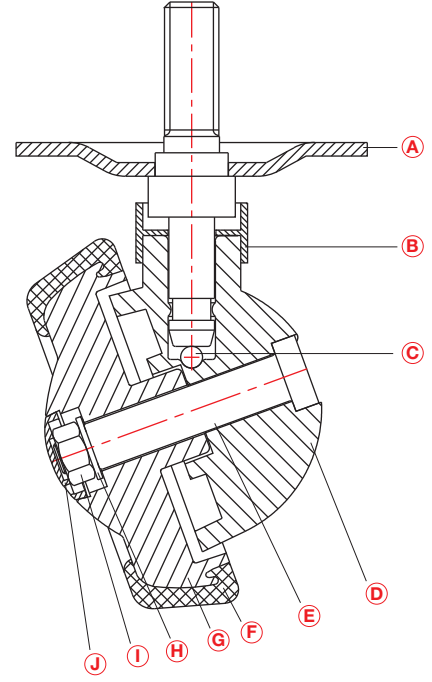

PUB POLİAMİD KASNAK ÜZERİ POLİÜRETAN KAPLAMA BURÇLU

KOD NO	mm	mm	mm	mm	mm	kg
2104 PUB 070	70	18	68	8.3	33	50









- A:** CİVATALI TABLA
B: MUHAFAZA TOZLUK
C: KÜRESEL METAL TANE BİLYA
D: POLİAMİD GÖVDE
E: GÖBEK MONTAJ CİVATASI
F: P.V.C. KILIF
G: POLİAMİD KASNAK
H: MONTAJ RONDASI
I: M6 VURUŞLU SOMUN
J: SOMUN KAPAĞI









PCB POLİAMİD KASNAK ÜZERİ P.V.C. KAPLAMA BURÇLU

KOD NO	 mm	 mm	 mm	 mm	 mm	 mm	 kg
2111 PCB 070	70	18	88	M10	25	64.5x64.5	50
2111 PCB 090	90	19.5	116.5	M12	25	64.5x64.5	60



PUB POLİAMİD KASNAK ÜZERİ POLİÜRETAN KAPLAMA BURÇLU





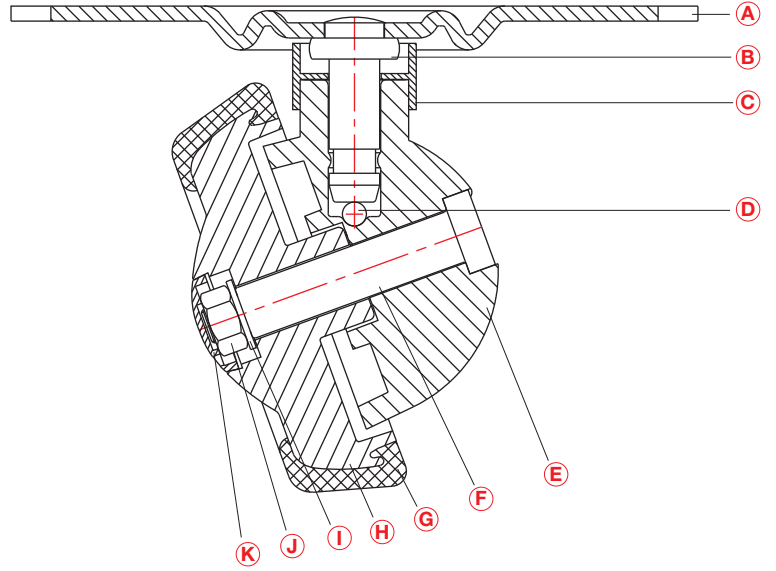

KOD NO	 mm	 mm	 mm	 mm	 mm	 mm	 kg
2111 PUB 070	70	18	88	M10	25	64.5x64.5	50
2111 PUB 090	90	19.5	116.5	M12	25	64.5x64.5	60

MMB MOBLEN TEKER BURÇLU

KOD NO	 mm	 mm	 mm	 mm	 mm	 mm	 kg
2111 MMB 095	95	40	116.5	M12	25	64.5x64.5	90

- A:** YAMUK BAĞLANTI TABLASI
- B:** BAĞLANTI PERÇİNİ
- C:** MUHAFAZA TOZLUK
- D:** KÜRESEL METAL TANE BİLYA
- E:** POLİAMİD GÖVDE
- F:** GÖBEK MONTAJ CİVATASI
- G:** P.V.C. KILIF
- H:** POLİAMİD KASNAK
- I:** MONTAJ RONDELASI
- J:** M6 VURUŞLU SOMUN
- K:** SOMUN KAPAĞI









PCB		POLİAMİD KASNAK ÜZERİ P.V.C. KAPLAMA BURÇLU						
KOD NO	 mm	 mm	 mm	 mm	 mm	 mm	 kg	
2112 PCB 070	70	18	82	114x58x77	89x25x63.5	6.2	50	
2112 PCB 090	90	19.5	110.5	114x58x77	89x25x63.5	6.2	60	









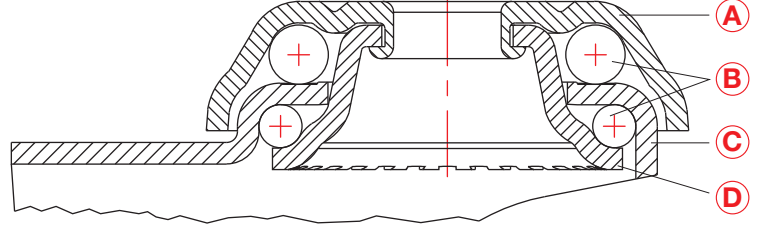

PUB		POLİAMİD KASNAK ÜZERİ POLİÜRETAN KAPLAMA BURÇLU						
KOD NO	 mm	 mm	 mm	 mm	 mm	 mm	 kg	
2112 PUB 070	70	18	82	114x58x77	89x25x63.5	6.2	50	
2112 PUB 090	90	19.5	110.5	114x58x77	89x25x63.5	6.2	60	









MMB		MOBLEN TEKER BURÇLU						
KOD NO	 mm	 mm	 mm	 mm	 mm	 mm	 kg	
2112 MMB 095	95	40	114	114x58x77	89x25x63.5	6.2	90	

- A:** ÜST BİLYA KAPAĞI
B: KÜRESEL METAL TANE BİLYALAR
C: OYNAK RULET MAŞASI
D: ALT BİLYA ÇANAĞI







**MMB****MOBLEN TEKER BURÇLU**

KOD NO	 mm	 mm	 mm	 mm	 mm	 mm	 kg
2700 MMB 050	50	2x20	50	72	30	10	50
2700 MMB 075	75	2x25	63	98	32	10	90







**MMB****MOBLEN TEKER BURÇLU**

KOD NO	 mm	 mm	 mm	 mm	 mm	 mm	 kg
2700 MMB 050 F18	50	2x20	50	72	30	84	50
2700 MMB 075 F18	75	2x25	63	98	32	90	90







**MTB****MOBLEN KASNAK ÜZERİ TERMOELASTİK KAPLAMA BURÇLU**

KOD NO	 mm	 mm	 mm	 mm	 mm	 mm	 kg
2700 MTB 050	50	2x20	50	72	30	10	50
2700 MTB 075	75	2x25	63	98	32	10	90







**MTB****MOBLEN KASNAK ÜZERİ TERMOELASTİK KAPLAMA BURÇLU**

KOD NO	 mm	 mm	 mm	 mm	 mm	 mm	 kg
2700 MTB 050 F18	50	2x20	50	72	30	84	50
2700 MTB 075 F18	75	2x25	63	98	32	90	90









PPB		POLİAMİD TEKER BURÇLU						
KOD NO	 mm	 mm	 mm	 mm	 mm	 mm	 kg	
2700 PPB 050	50	2x20	50	72	30	10	50	
2700 PPB 075	75	2x25	63	98	32	10	90	









PPB		POLİAMİD TEKER BURÇLU						
KOD NO	 mm	 mm	 mm	 mm	 mm	 mm	 kg	
2700 PPB 050 F18	50	2x20	50	72	30	84	50	
2700 PPB 075 F18	75	2x25	63	98	32	90	90	



HCB		POLİKARBONAT KASNAK ÜZERİ P.V.C. KAPLAMA BURÇLU						
KOD NO	 mm	 mm	 mm	 mm	 mm	 mm	 kg	
2700 HCB 050	50	2x20	50	72	30	10	50	
2700 HCB 075	75	2x25	63	98	32	10	90	



HCB		POLİKARBONAT KASNAK ÜZERİ P.V.C. KAPLAMA BURÇLU						
KOD NO	 mm	 mm	 mm	 mm	 mm	 mm	 kg	
2700 HCB 050 F18	50	2x20	50	72	30	84	50	
2700 HCB 075 F18	75	2x25	63	98	32	90	90	

- A:** BAĞLANTI CİVATASI
- B:** ÜST BİLYA KAPAĞI
- C:** KÜRESEL METAL TANE BİLYALAR
- D:** OYNAK RULET MAŞASI
- E:** ALT BİLYA ÇANAĞI

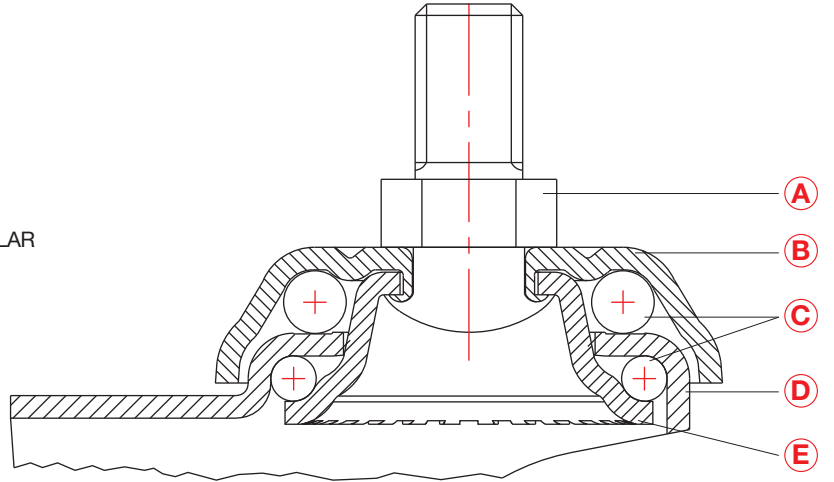
MMB MOBLEN TEKER BURÇLU

KOD NO	mm	mm	mm	mm	mm	mm	mm	kg
2701 MMB 050	50	2x20	50	78	30	3/8"	15	50

MMB MOBLEN TEKER BURÇLU

KOD NO	mm	mm	mm	mm	mm	mm	mm	kg
2701 MMB 050 F18	50	2x20	50	78	30	84	3/8"	50

MTB MOBLEN KASNAK ÜZERİ TERMOELASTİK KAPLAMA BURÇLU









KOD NO	mm	mm	mm	mm	mm	mm	mm	kg
2701 MTB 050	50	2x20	50	78	30	3/8"	15	50

MTB MOBLEN KASNAK ÜZERİ TERMOELASTİK KAPLAMA BURÇLU









KOD NO	mm	mm	mm	mm	mm	mm	mm	kg
2701 MTB 050 F18	50	2x20	50	78	30	84	3/8"	50













PPB		POLİAMİD TEKER BURÇLU							
KOD NO									
	mm	mm	mm	mm	mm	mm	mm	kg	
2701 PPB 050	50	2x20	50	78	30	3/8"	15	50	



PPB		POLİAMİD TEKER BURÇLU							
KOD NO									
	mm	mm	mm	mm	mm	mm	mm	kg	
2701 PPB 050 F18	50	2x20	50	78	30	84	3/8"	15	50



HCB		POLİKARBONAT KASNAK ÜZERİ P.V.C. KAPLAMA BURÇLU							
KOD NO									
	mm	mm	mm	mm	mm	mm	mm	kg	
2701 HCB 050	50	2x20	50	78	30	3/8"	15	50	



HCB		POLİKARBONAT KASNAK ÜZERİ P.V.C. KAPLAMA BURÇLU							
KOD NO									
	mm	mm	mm	mm	mm	mm	mm	kg	
2701 HCB 050 F18	50	2x20	50	78	30	84	3/8"	15	50

- A:** BAĞLANTI CİVATASI
- B:** ALTİGEN PUL
- C:** ÜST BİLYA KAPAĞI
- D:** KÜRESEL METAL TANE BİLYALAR
- E:** OYNAK RULET MAŞASI
- F:** KISA BORU PERÇİNİ
- G:** ALT BİLYA ÇANAĞI
- H:** MONTAJ PULU

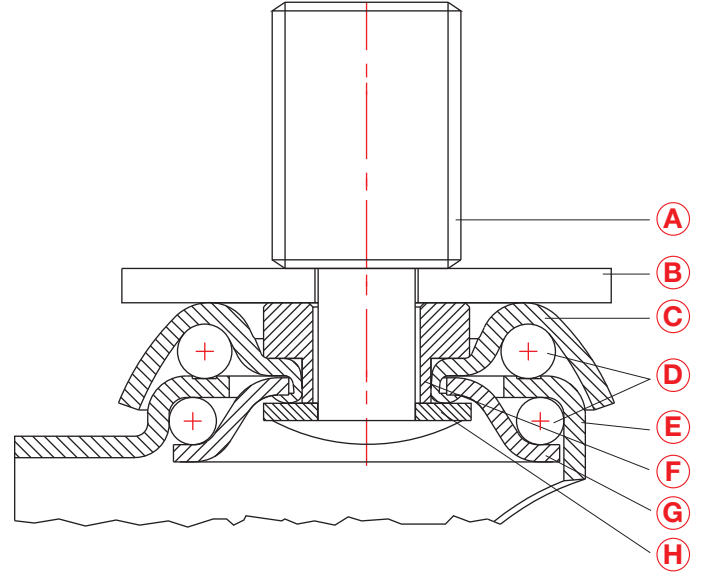
MMB MOBLEN TEKER BURÇLU

KOD NO	mm	mm	mm	mm	mm	mm	mm	mm	kg
2701 MMB 075	75	2x25	63	102	32	10	5/8"	25	90

MMB MOBLEN TEKER BURÇLU

KOD NO	mm	mm	mm	mm	mm	mm	mm	mm	kg	
2701 MMB 075 F18	75	2x25	63	102	32	90	10	5/8"	25	90

MTB MOBLEN KASNAK ÜZERİ TERMOELASTİK KAPLAMA BURÇLU









KOD NO	mm	mm	mm	mm	mm	mm	mm	mm	kg
2701 MTB 075	75	2x25	63	102	32	10	5/8"	25	90

MTB MOBLEN KASNAK ÜZERİ TERMOELASTİK KAPLAMA BURÇLU









KOD NO	mm	mm	mm	mm	mm	mm	mm	mm	kg	
2701 MTB 075 F18	75	2x25	63	102	32	90	10	5/8"	25	90





PPB		POLİAMİD TEKER BURÇLU								
KOD NO										
	mm	mm	mm	mm	mm	mm	mm	mm	kg	
2701 PPB 075	75	2x25	63	102	32	10	5/8"	25	90	



PPB		POLİAMİD TEKER BURÇLU								
KOD NO										
	mm	mm	mm	mm	mm	mm	mm	mm	kg	
2701 PPB 075 F18	75	2x25	63	102	32	90	10	5/8"	25	90











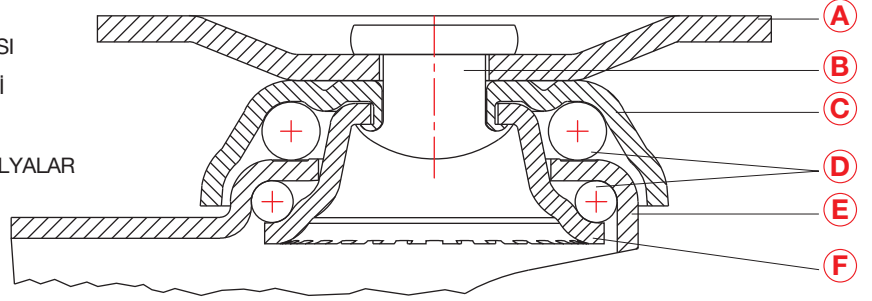

HCB		POLİKARBONAT KASNAK ÜZERİ P.V.C. KAPLAMA BURÇLU								
KOD NO										
	mm	mm	mm	mm	mm	mm	mm	mm	kg	
2701 HCB 075	75	2x25	63	102	32	10	5/8"	25	90	











HCB		POLİKARBONAT KASNAK ÜZERİ P.V.C. KAPLAMA BURÇLU								
KOD NO										
	mm	mm	mm	mm	mm	mm	mm	mm	kg	
2701 HCB 075 F18	75	2x25	63	102	32	90	10	5/8"	25	90

- A:** OYNAK BAĞLANTI TABLASI
B: TABLA BAĞLANTI PERÇİNİ
C: ÜST BİLYA KAPAĞI
D: KÜRESEL METAL TANE BİLYALAR
E: OYNAK RULET MAŞASI
F: ALT BİLYA ÇANAĞI









**MMB****MOBLEN TEKER BURÇLU**

KOD NO	 mm	 mm	 mm	 mm	 mm	 mm	 mm	 mm	 kg
2702 MMB 050	50	2x20	50	79	30	64.5x64.5	45x53	12x6.5	50
2702 MMB 075	75	2x25	63	102	32	77.5x67.5	55x47	8.5x9.5	90









**MMB****MOBLEN TEKER BURÇLU**

KOD NO	 mm	 mm	 mm	 mm	 mm	 mm	 mm	 mm	 kg	
2702 MMB 050 F18	50	2x20	50	79	30	84	64.5x64.5	45x53	12x6.5	50
2702 MMB 075 F18	75	2x25	63	102	32	90	77.5x67.5	55x47	8.5x9.5	90

**MTB****MOBLEN KASNAK ÜZERİ TERMOELASTİK KAPLAMA BURÇLU**

KOD NO	 mm	 mm	 mm	 mm	 mm	 mm	 mm	 mm	 kg
2702 MTB 050	50	2x20	50	79	30	64.5x64.5	45x53	12x6.5	50
2702 MTB 075	75	2x25	63	102	32	77.5x67.5	55x47	8.5x9.5	90

**MTB****MOBLEN KASNAK ÜZERİ TERMOELASTİK KAPLAMA BURÇLU**

KOD NO	 mm	 mm	 mm	 mm	 mm	 mm	 mm	 mm	 kg	
2702 MTB 050 F18	50	2x20	50	79	30	84	64.5x64.5	45x53	12x6.5	50
2702 MTB 075 F18	75	2x25	63	102	32	90	77.5x67.5	55x47	8.5x9.5	90



PPB		POLİAMİD TEKER BURÇLU								
KOD NO										
	mm	mm	mm	mm	mm	mm	mm	mm	mm	kg
2702 PPB 050	50	2x20	50	79	30	64.5x64.5	45x53	12x6.5		50
2702 PPB 075	75	2x25	63	102	32	77.5x67.5	55x47	8.5x9.5		90



PPB		POLİAMİD TEKER BURÇLU								
KOD NO										
	mm	mm	mm	mm	mm	mm	mm	mm	mm	kg
2702 PPB 050 F18	50	2x20	50	79	30	84	64.5x64.5	45x53	12x6.5	50
2702 PPB 075 F18	75	2x25	63	102	32	90	77.5x67.5	55x47	8.5x9.5	90









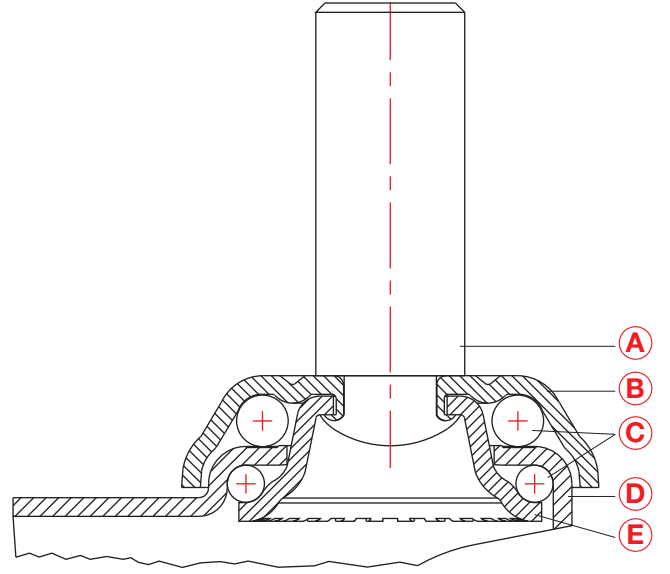

HCB		POLİKARBONAT KASNAK ÜZERİ P.V.C. KAPLAMA BURÇLU								
KOD NO										
	mm	mm	mm	mm	mm	mm	mm	mm	mm	kg
2702 HCB 050	50	2x20	50	79	30	64.5x64.5	45x53	12x6.5		50
2702 HCB 075	75	2x25	63	102	32	77.5x67.5	55x47	8.5x9.5		90











HCB		POLİKARBONAT KASNAK ÜZERİ P.V.C. KAPLAMA BURÇLU								
KOD NO										
	mm	mm	mm	mm	mm	mm	mm	mm	mm	kg
2702 HCB 050 F18	50	2x20	50	79	30	84	64.5x64.5	45x53	12x6.5	50
2702 HCB 075 F18	75	2x25	63	102	32	90	77.5x67.5	55x47	8.5x9.5	90

- A:** BAĞLANTI PİMİ
B: ÜST BİLYA KAPAĞI
C: KÜRESEL METAL TANE BİLYALAR
D: OYNAK RULET MAŞASI
E: ALT BİLYA ÇANAĞI











MMB		MOBLEN TEKER BURÇLU							
KOD NO	 mm	 mm	 mm	 mm	 mm	 mm	 mm	 kg	
2705 MMB 050	50	2x20	50	79	30	16	40	50	
2705 MMB 075	75	2x25	63	102	32	19	40	90	











MMB		MOBLEN TEKER BURÇLU							
KOD NO	 mm	 mm	 mm	 mm	 mm	 mm	 mm	 mm	 kg
2705 MMB 050 F18	50	2x20	50	79	30	84	16	40	50
2705 MMB 075 F18	75	2x25	63	102	32	90	19	40	90











MTB		MOBLEN KASNAK ÜZERİ TERMOELASTİK KAPLAMA BURÇLU							
KOD NO	 mm	 mm	 mm	 mm	 mm	 mm	 mm	 kg	
2705 MTB 050	50	2x20	50	79	30	16	40	50	
2705 MTB 075	75	2x25	63	102	32	19	40	90	











MTB		MOBLEN KASNAK ÜZERİ TERMOELASTİK KAPLAMA BURÇLU							
KOD NO	 mm	 mm	 mm	 mm	 mm	 mm	 mm	 mm	 kg
2705 MTB 050 F18	50	2x20	50	79	30	84	16	40	50
2705 MTB 075 F18	75	2x25	63	102	32	90	19	40	90











PPB		POLİAMİD TEKER BURÇLU							
KOD NO	 mm	 mm	 mm	 mm	 mm	 mm	 mm	 kg	
2705 PPB 050	50	2x20	50	79	30	16	40	50	
2705 PPB 075	75	2x25	63	102	32	19	40	90	





PPB		POLİAMİD TEKER BURÇLU							
KOD NO	 mm	 mm	 mm	 mm	 mm	 mm	 mm	 kg	
2705 PPB 050 F18	50	2x20	50	79	30	84	16	40	50
2705 PPB 075 F18	75	2x25	63	102	32	90	19	40	90



HCB		POLİKARBONAT KASNAK ÜZERİ P.V.C. KAPLAMA BURÇLU							
KOD NO	 mm	 mm	 mm	 mm	 mm	 mm	 mm	 kg	
2705 HCB 050	50	2x20	50	79	30	16	40	50	
2705 HCB 075	75	2x25	63	102	32	19	40	90	





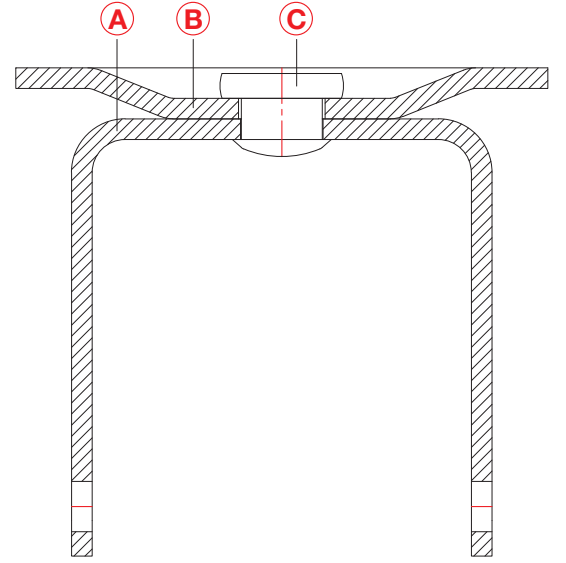





HCB		POLİKARBONAT KASNAK ÜZERİ P.V.C. KAPLAMA BURÇLU							
KOD NO	 mm	 mm	 mm	 mm	 mm	 mm	 mm	 kg	
2705 HCB 050 F18	50	2x20	50	79	30	84	16	40	50
2705 HCB 075 F18	75	2x25	63	102	32	90	19	40	90











- A:** SABİT RULET MAŞASI
B: SABİT BAĞLANTI TABLASI
C: TABLA BAĞLANTI PERÇİNİ









**MMB****MOBLEN TEKER BURÇLU**

KOD NO	 mm	 mm	 mm	 mm	 mm	 mm	 mm	 kg
2707 MMB 050	50	2x20	50	79	64.5x64.5	45x53	12x6.5	50
2707 MMB 075	75	2x25	63	102	77.5x67.5	55x47	8.5x9.5	90









**MTB****MOBLEN KASNAK ÜZERİ TERMOELASTİK KAPLAMA BURÇLU**

KOD NO	 mm	 mm	 mm	 mm	 mm	 mm	 mm	 kg
2707 MTB 050	50	2x20	50	79	64.5x64.5	45x53	12x6.5	50
2707 MTB 075	75	2x25	63	102	77.5x67.5	55x47	8.5x9.5	90

**PPB****POLİAMİD TEKER BURÇLU**

KOD NO	 mm	 mm	 mm	 mm	 mm	 mm	 mm	 kg
2707 PPB 050	50	2x20	50	79	64.5x64.5	45x53	12x6.5	50
2707 PPB 075	75	2x25	63	102	77.5x67.5	55x47	8.5x9.5	90

**HCB****POLİKARBONAT KASNAK ÜZERİ P.V.C. KAPLAMA BURÇLU**

KOD NO	 mm	 mm	 mm	 mm	 mm	 mm	 mm	 kg
2707 HCB 050	50	2x20	50	79	64.5x64.5	45x53	12x6.5	50
2707 HCB 075	75	2x25	63	102	77.5x67.5	55x47	8.5x9.5	90



KAMA PRES SANAYİ ve TİCARET A.Ş.

Evren Mahallesi Gülbahar Caddesi No: 92
34212 Bağcılar - İSTANBUL - TURKEY

Tel: +90.212.655 21 00 PBX • Fax: +90.212.550 35 29
www.kama.com.tr • e-mail: satis@kama.com.tr

